



PHOENICS – Your Gateway to CFD Success

Documentation for PHOENICS | TR 315

PHOENICS-ESTER User Guide.

CHAM Ref: CHAM/TR315

Document rev: 8

Doc. release date: 20 September 2022

Software version: PHOENICS 2022 v1.0

Responsible author: J C Ludwig

Editor: J C Ludwig

Published by: CHAM

Confidentiality:

Classification: Unclassified

The copyright covers the exclusive rights to reproduction and distribution including reprints, photographic reproductions, microform or any other reproductions of similar nature, and translations. No part of this publication may be reproduced, stored in a retrieval system or transmitted in any form or by any means, electronic, electrostatic, magnetic tape, mechanical, photocopying, recording or otherwise, without permission in writing from the copyright holder.

© Copyright Concentration, Heat and Momentum Limited 2022

CHAM, Bakery House, 40 High Street, Wimbledon, London SW19 5AU, UK
Telephone: 020 8947 7651 Fax: 020 8879 3497
E-mail: phoenics@cham.co.uk Web site: <https://www.cham.co.uk>



CHAM – Your Gateway to CFD Success

PHOENICS-ESTER Reference Guide: TR 315

Table of Contents

1.	Foreword	4
2.	Introduction	5
3.	ESTER Main menu	6
4.	Geometry	7
4.1	Anode Settings	8
4.2	Electrical Connections to the Anodes	13
4.3	Cathode Settings	14
4.4	Electrical Connections to the Cathodes	15
5.	Meshing	17
6.	Properties	19
7.	Models	20
8.	Boundary Conditions	22
8.1	Cathode Conditions	22
8.2	Anode Conditions	23
8.3	Magnetic Fields	25
8.4	Other Settings	25
9.	Numerics	26
10.	ESTER-Specific Output	28
11.	OBJECT Types Used by ESTER	30
11.1	Anode	30
11.2	Anode Stubs, Yokes, Rods, Bus- and Cross-bars	31
11.3	Cathode Blocks and Collector Bars	31
11.4	Freeze	32
11.5	Other Objects	32
12.	Post Processing	33
12.1	Displaying the metal - electrolyte interface	33
12.2	Plotting vectors of current	34
12.3	Plotting vectors of other vector quantities	35
12.4	Creating Animations	35
12.5	Monitoring Rod Voltage and Current	35
12.6	Monitoring Collector-bar currents	36
12.7	Monitoring the Interface Height	36
13.	Q1 Settings	37

13.1	Domain Settings	37
13.2	Variables Passed to ESTRGR	39
13.3	Anode Object	41
13.4	Additional Monitoring flags	41
Appendix A. Mathematical Background		43
A.1	Some notes on the solution of the General Conservation Equation	43
A.2	Momentum Sources	43
A.3	The Potential Equation and Current Calculations	43
A.4	Potential Equation Sources	44
A.5	Magnetic Fields	46
Appendix B. Location of Anodes		47
Appendix C. Freeze		49
Appendix D. The Moving Grid and the Metal-Electrolyte Interface		50
Appendix E. ESTER File Formats		51

1. Foreword

ESTER (Electrolytic SmELTER) is a special purpose adaptation of the general purpose fluid flow and heat transfer code PHOENICS. It is attached to the PHOENICS Earth Solver as an additional GROUND station. The standard PHOENICS pre-processor with additional dialogs and menus is used for data input, and the standard post-processor with additional macros for graphical display.

The following document serves as a user guide for ESTER as of July 2021. It describes the non-standard features making up ESTER – the user is referred to the general PHOENICS manual ([CHAM TR326 PHOENICS-VR Reference Guide](#)) for descriptions of the remaining, standard, features.

This version of ESTER contains numerous new features and has been extended to incorporate complex anode rod and cathode configurations as discussed later in this document.

The following image shows a typical ESTER display.

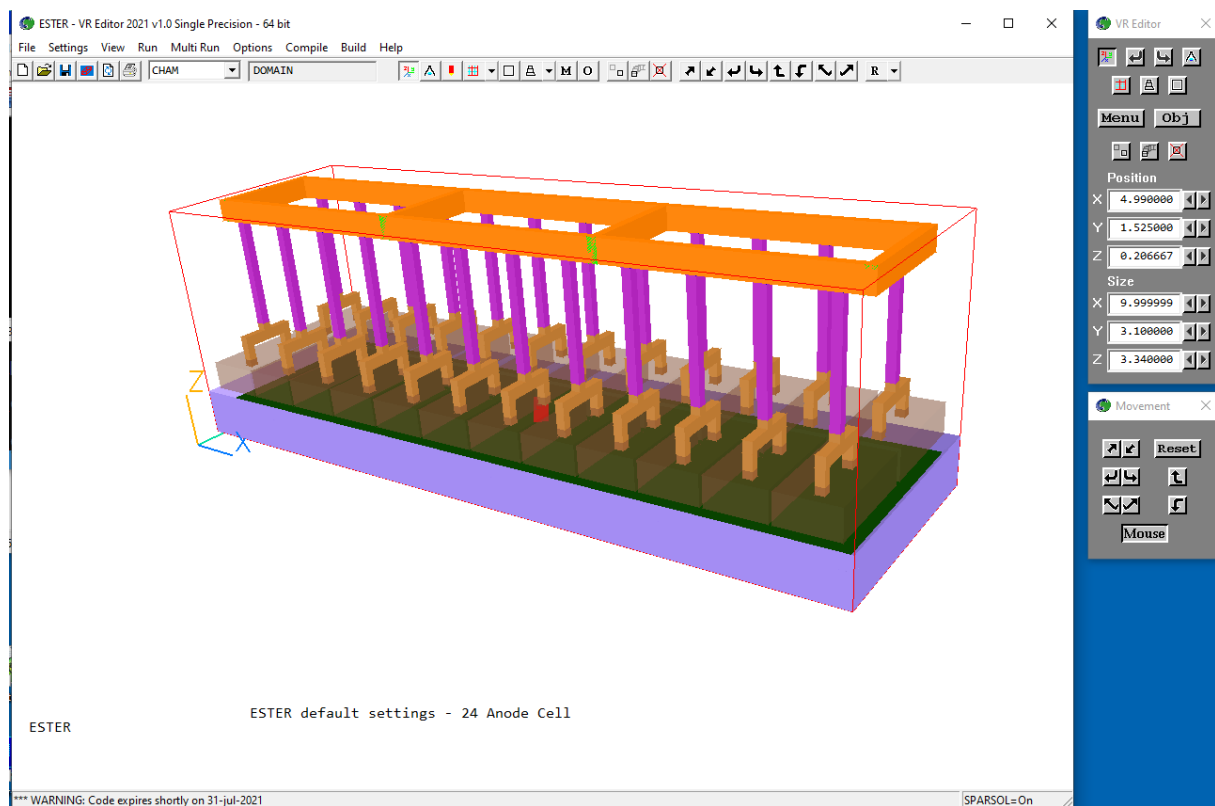

2. Introduction

ESTER solves for the steady state or transient fluid flow and electric potential distributions within an aluminium reduction cell of the Hall Cell type that is found prevalently in industrial aluminium smelting. The equations solved are pressure, $P1$, three velocity components $U1$, $V1$ and $W1$, and the electric potential EPOT.

A primary feature of the Hall Cell is the presence of two distinct layers of fluid, which never intermingle. The liquid metal is at the bottom, in contact with the cathode. The upper layer is the electrolyte, into which the anodes are immersed. The height of the metal-electrolyte interface is adjusted periodically to maintain hydrostatic equilibrium across the interface. The Lorentz forces driving the flow cause pressure differences across the interface, which then deforms.

The enormous difference in conductivity between metal and electrolyte means that even small changes in interface height can significantly alter the resistance paths, and hence current distributions. This then feeds back to the Lorentz forces and the height distribution. (More mathematical and technical details can be found in Appendix A to this document).

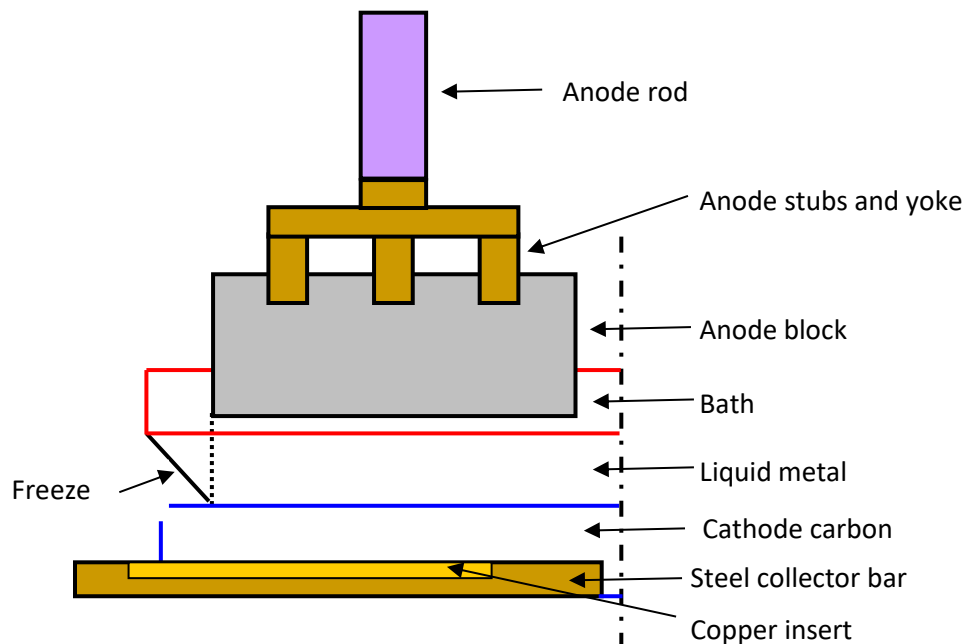

Whilst by default, ESTER solves only for the fluid behaviour and the electric potential, the two-phase option of PHOENICS can also be activated to model the dispersion of gas bubbles from the anode undersides, through the inter-anode and anode-wall gaps.

A schematic representation of the Hall type electrolysis cell is shown below:



The rest of this document discusses in some detail how to build the geometry illustrated above and how to access and control all the model parameters relevant to an ESTER simulation. (We again remind the reader to refer to the PHOENICS-VR Reference Guide (TR326) in order to clarify any general aspects of PHOENICS with which they are unfamiliar).

3. ESTER Main menu

The controls for the anode and cathode configurations, and all other model parameters are located on the ESTER Main Menu. To display this menu, click the Menu icon  on the tool bar, or the Menu button  on the hand-set. Either action will result in this dialog appearing:

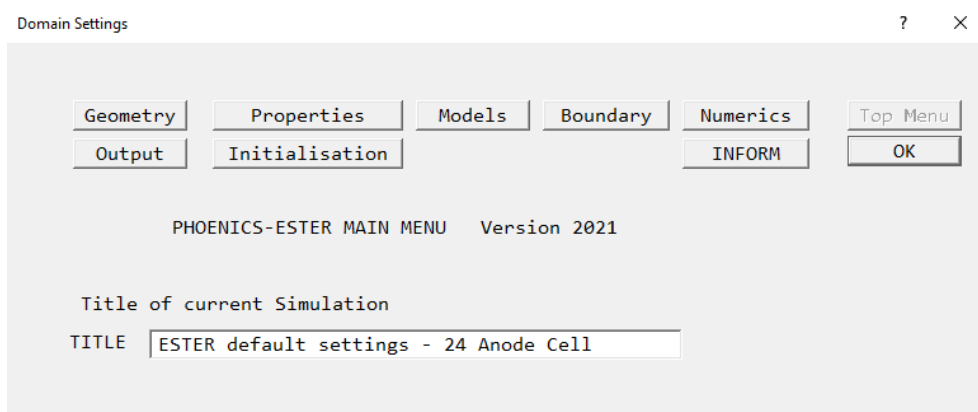

The structure of these menus will be familiar to general PHOENICS users. The features unique to ESTER are restricted to the top line of buttons – the Geometry / Properties / Models / Boundary and Numerics panels. For descriptions of the Output, Initialisation and INFORM panels please refer to [TR326, PHOENICS-VR Reference Guide](#).

The functions of the ESTER-specific panels are as follows:

- **Geometry** – sets the size of the reduction cell, the anode and cathode configurations and can control the meshing.
- **Properties** – sets the density and laminar kinematic viscosity of the metal and electrolyte, and the electrical conductivities of the materials used in the construction of the cell.
- **Models** – controls whether the potential equation is solved, and which terms are included in the interface-height adjustment sequence.
- **Boundary** – sets the cell current and voltage, the voltages at the anode rods, the currents at the busbar and collector bars, and the magnetic field initialisation.
- **Numerics** – sets the numerical controls for the solution.
- **Output** – sets ESTER-specific output controls.

Each of these panels will now be described in detail.

4. Geometry

The fundamental geometry of the electrolysis cell to be modelled is governed by the 'Geometry' tab. Clicking this button brings up the following dialog box:

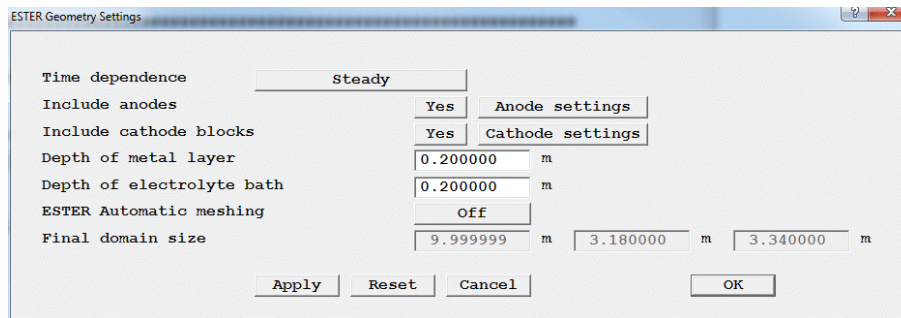

- **Time dependence:** when set to **Steady** the calculation is steady-state.

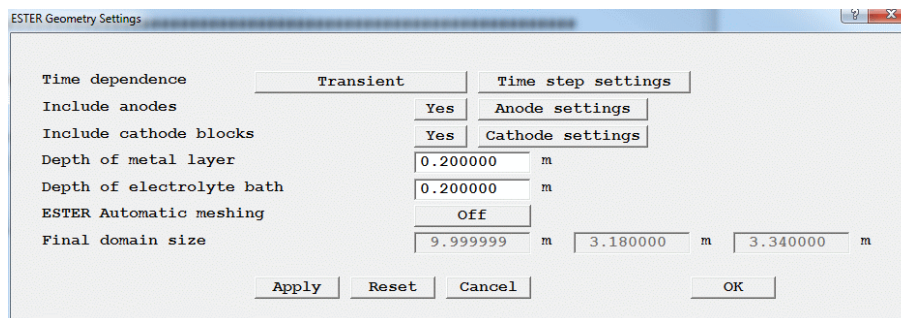

When set to **Transient**, the calculation is transient, and the iterative solution procedure will be repeated at each time step. The number of steps to perform and the time step size is set from the **Time step settings** dialog.

- **Include anodes:** when set to **Yes**, the anodes, and at the user's choice the stubs, yokes, rods and busbars are included in the model. When set to **No**, the anodes are not included at all, and the solution domain ends at the upper surface of the electrolyte layer.
- **Include cathode blocks:** when set to **Yes**, the cathode blocks, and at the user's choice the collector bars, are included in the model. When set to **No**, the solution domain starts at the upper surface of the cathode blocks.
- **Depth of metal layer:** sets the depth of the metal layer above the cathode blocks.
- **Depth of electrolyte bath:** sets the total depth of the electrolyte bath.

The overall dimensions of the model are displayed at the bottom of this panel (but note this is not user input but calculated internally).

- **Anode Settings:** This button is only shown if the anodes are to be included. It displays the anode settings panel which allows the user to select anode properties such as their dimensions and number, together with whether stubs, cross-bars, busbars, tapping gaps and connectors are present or not. The dimensions of these objects are also set here together with other variables such as the inter-anode spacing, anode to cathode distance and freeze block inclusion. (See 4.1 **Anode Settings** below for more detail).
- **Cathode Settings:** This button is only shown if the cathode blocks are to be included. It displays the cathode setting panel where the user can control the cathode block dimensions together with whether collector bars are to be included and, if so, their geometry. The user may also add electrical contacts in the form of copper and cast iron inserts to the collector bars. Finally,

there is also the option to import CAD geometry if an alternative cathode geometry (rather than the default cuboid type) is desired. (See 4.3 **Cathode Settings** below for more detail).

- **Meshing:** If automatic meshing is toggled ON, the user has the option to click the ‘meshing’ button. This displays the ESTER automatic meshing dialog box where the user can specify the number of cells in key regions in the electrolysis cell. NOTE: If automatic meshing is turned off, users can control the grid manually. (See 5 **Meshing** below for more detail.)

4.1 Anode Settings

Selecting ‘Anode settings’ displays the following dialog box (where, in this case, everything has been toggled as ‘On’):

Coordinate directions	X	Y	Z
Number of anodes	12	2	
Anode size	0.770000 m	1.400000 m	0.400000 m
Include tapping gap(s)	No		
Regular inter-anode gap	0.040000 m	0.100000 m	
Anode to wall distance	0.160000 m	0.100000 m	
Anode to cathode distance (ACD)			0.040000 m
Anode rod/yoke/stub configuration	1*2		
Anode stub diameter	0.130000 m		
Depth of stub in anode			0.100000 m
Anode yoke distance (top to top)			0.350000 m
Anode yoke dimensions	0.120000 m	0.810000 m	0.150000 m
Anode rod dimensions	0.120000 m	0.120000 m	1.500000 m
Yoke to anode rod steel connector			0.100000 m
Include cast iron layer	No		
Include busbars and crossbars	Yes		
Busbar dimensions	9.680000 m	0.120000 m	0.300000 m
Number of crossbars	4	Set crossbar size / pos	
Current entry points			
Number of side entry points	4	End entry points	0
Set entry point sizes and locations			
Include freeze ledges	Yes		
Freeze toe to anode edge	0.000000 m		

- **Number of anodes:** sets the number of anodes in the X and Y directions. (Note: there can be only a single layer of anodes in the z direction).
- **Anode size:** sets the physical size of the anodes in the X, Y and Z directions.
- **Include tapping gap(s):** A tapping gap represents a physical space between anodes where metal is siphoned out of the cell. Geometrically, it appears as a spacing that is larger than the regular inter-anode gap. The user can choose to include such gaps if desired.
- **Tapping gap in direction:** controls whether the tapping gap(s) are in the X or Y direction.
- **Number of gaps:** If activated, there can be one or two tapping gaps.
- **Gap size:** is the size of each tapping gap.
- **Gap after anode:** this entry places the gap(s) after the anode number(s) selected. Anode 1 is the left-most.

The effect of activating the tapping gap is shown in the figure below, where two gaps are set in X, after the sixth and seventh anodes.

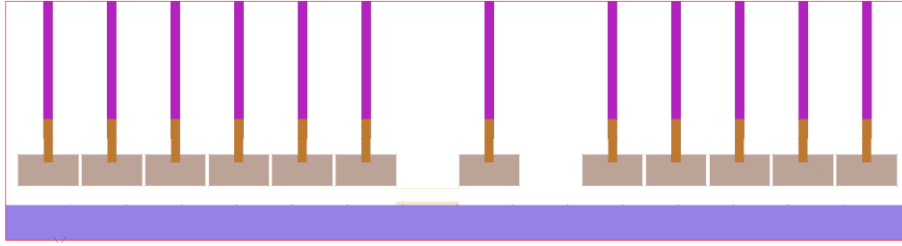

Example of two tapping gaps (of 0.8m each) in the x direction after anode numbers 6 & 7.

- **Regular inter-anode gap:** controls the regular spacing in X and Y between each of the anode blocks.
- **Anode to wall distance:** controls the size of the gap between the left or right edge of the domain and the start and end of the adjacent anode blocks. The gaps are equal at both ends and can be set separately in X and Y.
- **Anode to cathode distance (ACD):** controls the vertical (Z) distance from the base of the anode block to the top of the metal layer beneath the electrolyte solution. (Note: Following standard convention, this does NOT in fact measure the physical distance from anode to cathode).
- **Anode/stub yoke configuration:** this button displays the following drop-down menu:

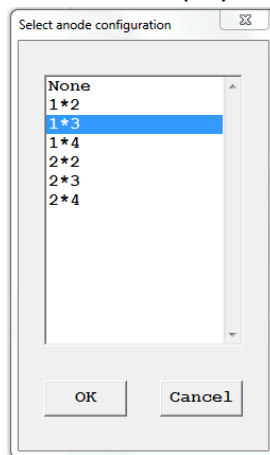

From here the user can select whether anode rods, yokes and stubs are to be included in the model. Note that rods, yokes and stubs are all coupled – one cannot have a rod without stubs and yokes.

If 'None' is chosen, the solution domain ends at the upper surface of the anode blocks. If one of the other configurations is chosen, then the stubs, yokes and rods will be included in the model.

The m*n nomenclature refers to the number of stubs in X and Y respectively. The 1*2 – 2*2 configurations apply to a single anode, each fed by a single rod. The 2*2 and 2*4 configurations apply to pairs of adjacent (in X) anodes. These are joined by the yoke and are fed by a single rod per pair.

The next table shows the available configurations.

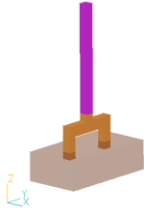
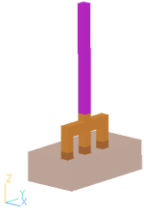
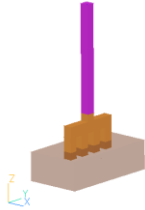
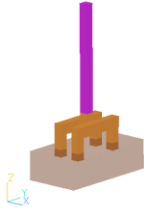
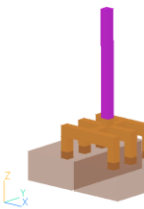
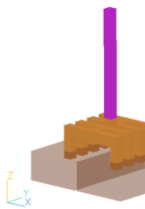
		
1 * 2	1 * 3	1 * 4
		
2 * 2	2 * 3	2 * 4

- **Anode stub diameter:** the diameter of the anode stubs (in the model the stubs are treated as square with the equivalent area).
- **Depth of stub in anode:** the depth to which the stub is embedded in the anode block.
- **Anode yoke distance (top to top):** the distance from the top of the anode block to the top of the yoke.
- **Anode yoke dimensions:** the dimensions of the yoke in X, Y and Z.
- **Anode rod dimensions:** the dimensions of the anode rod in X, Y and Z.
- **Yoke to anode rod steel connector:** the height of the steel connector between the yoke and the bottom of the anode rod, as shown below:

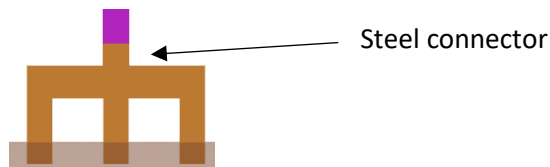

- **Include cast-iron layer:** when set to Yes, the cast iron layer surrounding the tips of the anode stubs immersed within the anode itself is included, to act as electrical contact layer. If toggled on, the user can then specify the thickness of this layer.

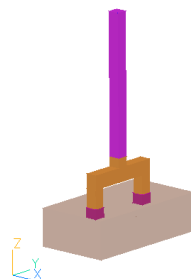

Note that this layer is treated as a sub-grid element, and does not need to be explicitly meshed.

- **Include bus and cross-bars:** incorporates electrical overhead rails into the model.

- **Busbar dimensions:** sets the dimensions of the busbars in X, Y and Z. The busbars are assumed to lie along the anode-rod centre lines in the Y direction. In the X direction they are located centrally in the cell, and in Z they sit on the top of the anode rods.
- **Number of cross-bars:** sets the number of cross bars joining the busbars. There are always at least two cross bars, one at each end of the busbars forming a closed ring. Any remaining cross bars can be freely located along the length of the bus bars. The image below shows 24 anodes with 2*3 yoke configuration, busbars and 4 cross bars.

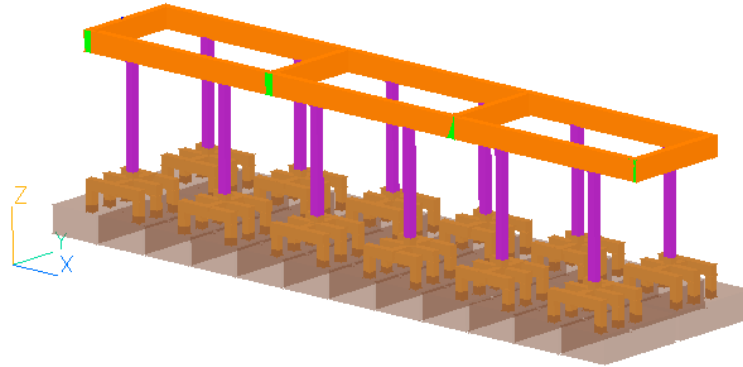

Busbars with four cross bars

- **Set crossbar size / pos:** This leads to a dialog from which the sizes and positions of the cross bars can be set.

		X size		X centre	
Crossbar	1	<input type="text" value="0.120000"/>	m	<input type="text" value="0.06"/>	m
Crossbar	2	<input type="text" value="0.120000"/>	m	<input type="text" value="3.246667"/>	m
Crossbar	3	<input type="text" value="0.120000"/>	m	<input type="text" value="6.433333"/>	m
Crossbar	4	<input type="text" value="0.120000"/>	m	<input type="text" value="9.62"/>	m

- **X size:** sets the size of the selected cross bar in the X direction.
- **X centre:** sets the location of the centre of the selected cross bar relative to the low-X end of the busbar. Note that the positions of the first and last crossbar are fixed internally to align with the busbar ends.
The **Y size** of the cross bars is set internally to just fit between the busbars. The **Z size** is fixed to the busbar Z height.
- **Set uniform size and spacing:** sets the sizes of all the crossbars to that of crossbar 1, and then distributes the crossbars evenly along the length of the busbar.
- **Number of side entry-points:** This sets the number of current entry-points along the low-Y face of the first busbar.
- **End entry-points:** This sets the number of current entry-points along the low- and high-X faces of the first and last cross bar.

There must be at least one current entry-point in total. There can be zero side or end entry-points.

- **Set entry-point sizes and locations:** This sets the size and position of the current entry-points. In the following image the number of end entry-points has been set to 2.

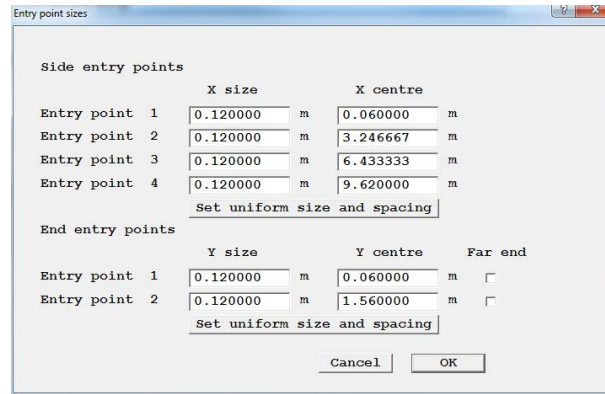

- **X / Y size:** This sets the X (for side entries) or Y (for end entries) size of the current entry-point. The sizes are trapped relative to the centre location such that the entry point does not extend beyond either end of the busbar.
- **X / Y centre:** This sets the X or Y location of the centre of the current entry-point relative to the start of the busbar. For side entries this is the low-X end, for end entries it is the low-Y face. The locations are trapped relative to the size such that the entry point does not extend beyond either end of the busbar.
- **Far end:** When not ticked, the end entry-point is on the low-X face of the first cross bar. When ticked, it is on the high-X face of the last cross bar.

The **Z size** is fixed to the busbar Z height.

- **Set uniform size and spacing:** sets the sizes of all the entry-points to that of entry-point 1, and then distributes the entry-points evenly along the length of the busbar (in X), or length of crossbar plus twice the busbar width (in Y).
- **Include freeze ledges:** when set to Yes, the freeze ledge at the edges of the domain will be included. Physically, this protects the cell, increasing its lifetime but reduces the effective area of the cathode.

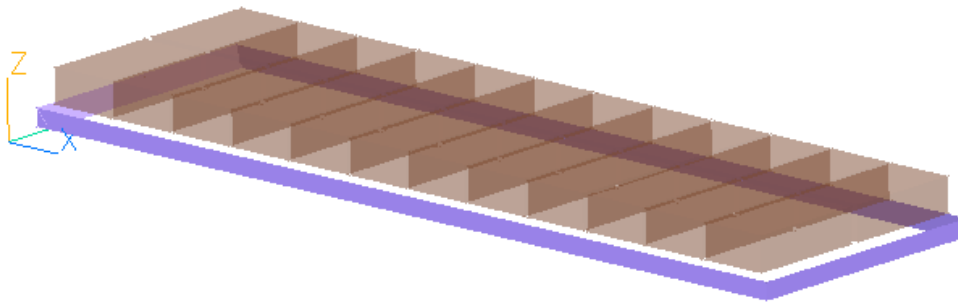

24-anode cell with freeze ledge

- **Freeze toe to anode edge:** this sets how far the freeze extends into the cell from the edges. A positive value means the freeze extends under the anodes, whereas a negative value means the freeze does not extend as far as the anode footprint on the cathode. Zero means it extends to the outline of the anode blocks. It cannot be more negative than the anode to wall gap.

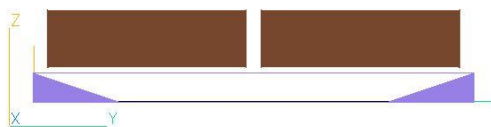

Positive toe to anode



Negative toe to anode

4.2 Electrical Connections to the Anodes

If the anode stubs and rods are not included, a single fixed potential condition is applied at the upper Z face of the solution domain. The program determines which cells lie inside an anode block, and applies the fixed voltage at those locations. The voltage can either be a fixed constant value, or a cell-by-cell distribution can be set by modifying the ESTRGR subroutine.

If the anode stubs and yokes are included, but the busbars are not, a fixed voltage condition is applied at the top of each anode rod. The potential at each rod is set on the Boundary panel – Section 8. The voltage locations are blue in the following image. One is circled in red.

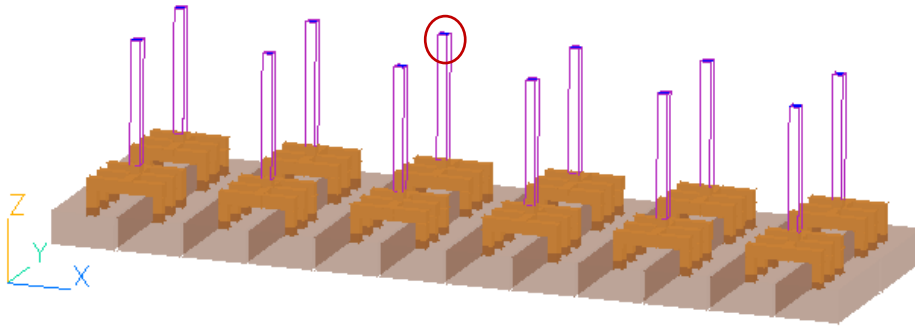

*Fixed-voltage locations (blue) for 24-anode cell with 2*3 yoke*

If the busbars are also included, then a fixed current condition is applied at each current entry-point and a fixed voltage is applied at the mid-point of the left-most cross bar. The current entry-points are green and the fixed voltage point is blue in the following image. The numbers, sizes and locations of the current entry-points and the cross bars can be different.

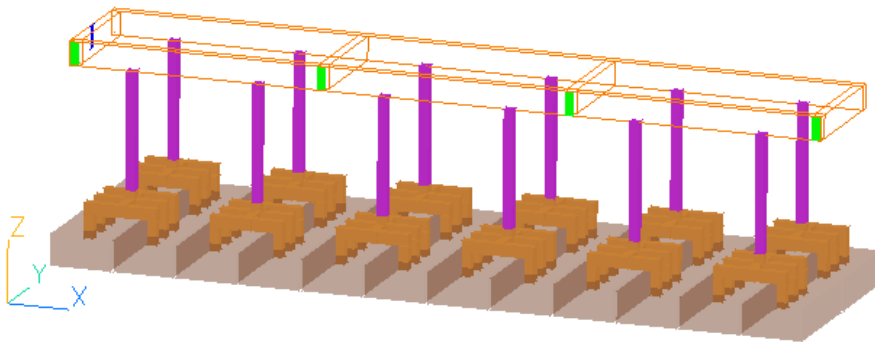

Fixed-current (green) and fixed-voltage (blue) locations on busbar

The actual values of the currents and anode potential are set in the Boundary panel – Section 8.

4.3 Cathode Settings

Selecting 'Cathode settings' brings up the following dialog box (all options are turned on)

Parameter	X	Y	Z
Number of cathode blocks	14	1	
Cathode dimensions (m)	0.703000	3.000000	0.450000
Default cathode geometry	CUBE14		
Include collector bars	Yes		
Number of collector bars/block	1	2	
Collector bar dimensions (m)	0.150000	1.450000	0.160000
Collector bar centre gap (m)	0.200000		
Include copper inserts	Yes		
Copper insert dimensions (m)	0.050000	1.300000	0.060000
Offset from domain edge (m)	0.000000		
Include cast iron inserts	Yes		
Cast iron insert dimensions (m)	0.005000		

- **Number of cathode blocks:** sets the number of cathode blocks in the X direction. It is assumed there is always one block in the Y direction.
- **Cathode dimensions:** sets the dimensions of the cathode blocks in X, Y and Z. The size * number in X and Y cannot exceed the overall cell size, which is determined by the number and size of anodes and inter-anode gaps. If the total size of the cathode carbon panel is less than the cell size, the free space at the edges is filled with an insulating material.
- **Default cathode geometry:** sets the name of the geometry file to be used when creating the cathode blocks. 'default' is a rectangular block, so will give a flat cathode upper surface. A different shape can be imported as a CAD file. This will then be used for all the cathode blocks.

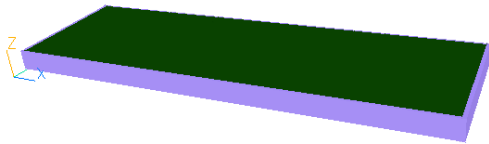

Default flat cathodes

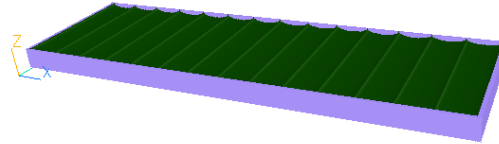

Shaped cathodes

The shape of each cathode block can also be set individually from the 'Shape' tab of the [Object Specification dialog](#) for an individual cathode by importing the geometry as a CAD file.

More information about importing CAD files is given in [TR326, PHOENICS-VR Reference Guide](#).

- **Include collector bars:** when set to Yes, the collector bars at the bottom of the cathode blocks are included in the model.
- **Number of collector bars/block:** sets the number of collector bars in X in each cathode block. Up to 3 collector bars per block are allowed as long as they will fit within the width of a cathode block. In the Y direction it is assumed that the bars extend to the edges of the cell. The number of bars is thus one if the centre gap is zero, or two if the centre gap is finite.
- **Collector bar dimensions:** sets the dimensions of the collector bars in the X, Y and Z directions. The number of bars per cathode block times the X size cannot exceed the X size of a cathode block. If twice the Y size plus the collector bar centre gap exceeds the bath width, the edges of the domain outboard the bath are filled with a non-conducting solid.
- **Collector bar centre gap:** If the centre gap is set to zero, then a single collector bar is placed parallel to the y-axis. If the gap is non-zero, then there are two separate collector bars parallel to the y-axis separated by this gap size. (Note: In order to refresh the dialog box on changing

the centre gap in order to update the number of collector bars in the y-direction, the user should press the **'Apply'** button.

The following image shows 14 cathode blocks, each with 2 collector bars giving a total of 28 collector bars in X. The centre gap is non-zero, so there are 2 bars in Y.

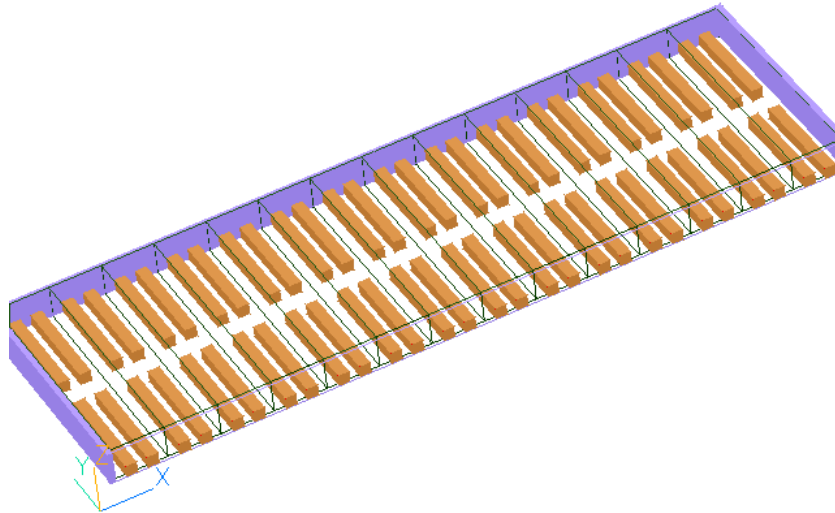

Two collector bars per cathode block, finite centre gap and filled edge gaps

- **Include copper inserts:** includes a copper insert *inside* the collector bar itself. It is located centrally immediately under the upper face of the collector bar.
- **Copper insert dimensions:** sets the X, Y and Z sizes of the copper insert. These may not be bigger than the collector bar itself.
- **Offset from domain edge:** sets the distance between the edge of the domain (and hence collector bar) and the start of the copper insert.
- **Include cast iron inserts:** includes a thin cast-iron layer around the *outside* of each collector bar.
- **Cast iron insert dimensions:** sets the thickness of the cast iron layer. Note that this layer is treated as a sub-grid element, and does not need to be explicitly meshed. The image below shows the cast-iron inserts and copper inserts.

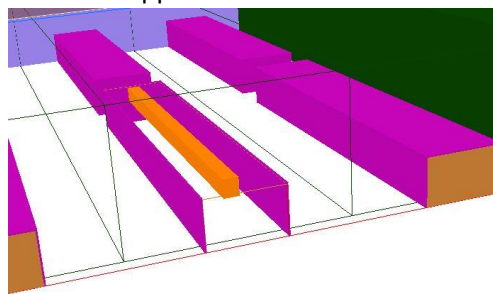

Cast-iron and copper inserts

4.4 Electrical Connections to the Cathodes

If the cathode blocks are **not** included, or if they **are** included but the collector bars are **not**, a single fixed-current condition is applied at the base of the solution domain. The current density can be a single fixed value, or a cell-by-cell distribution can be read from a file.

If the cathode blocks **and** collector bars are included, a fixed current extraction condition is applied at the ends of each collector bar. The following image shows the current-condition locations in red.

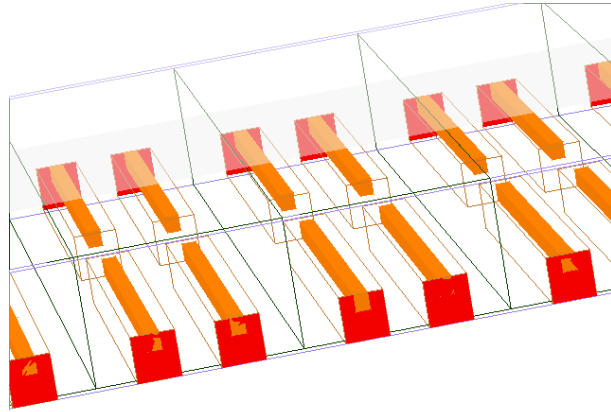

The current exit condition includes the copper inserts, if they are present.

The actual values of the cell current or the collector bar currents are set in the Boundary panel – Section 8.

5. Meshing

Selecting 'Meshing' displays the following dialog box

	X-direction	Y-direction	Z-direction
Cells in anodes	9	15	
Cells in inter-anode	2	2	
Cells in anode to wall	2	2	
Slabs in carbon blocks			
below copper inserts			2
in copper inserts			2
above copper inserts			4
Slabs in metal			5
Slabs in bath under anodes			4
Slabs in bath at anode immersion			3
Slabs in anodes above bath			3
Slabs in yokes			5
Slabs in rods			10
Slabs in bus bars			2
Total number of cells	134	36	40

If the automatic meshing option is set to ON, the user has access to the above dialogue box which allows the number of cells/slabs in important regions to be set. (A slab is a layer of cells in the Z-direction). The selected number of cells in the X- and Y-directions as well as slabs in the Z-direction will then be distributed as evenly as possible within the selected part of the domain.

The items which cause the grid to align with their edges are:

- The anodes in all three directions
- The top of the steel yoke-rod connector in Z
- The top of the anode rod in Z
- The upper surface of the electrolyte bath
- The metal-electrolyte interface in Z
- The top of the cathode blocks in Z
- The collector bars in Z
- The copper inserts in Z.

The ESTER auto-meshing dialog allows the number of cells in each of these zones to be set. The yokes, rods, bus- and cross-bars, cathode blocks, collector bars and copper inserts do not force the X and Y grid to align with their edges. Provided there is a reasonable number of cells, they will be detected correctly. The cast-iron inserts in the anodes and cathodes are always treated as sub-grid items.

If ESTER automatic meshing is OFF, all items (other than the cast iron inserts) cause the grid to align with their edges in all three directions. The standard PHOENICS [auto-meshing](#) will be turned on in X and Y.

In Z, the standard auto-mesh will be initially turned on, but the once the grid has been built around the geometry the Z-direction grid will be reset to manual and the number of Z planes in the bath under the anodes will be reset to that set in the ESTER dialog.

Any further changes then made by the user via the PHOENICS environment will be retained. To access the [meshing dialog](#), click the  icon on the menu bar or hand-set then click on the grid. The number of cells per grid region can now be set.

A file called 'grid.txt' containing the cell face locations in each coordinate direction is written whenever 'File – Save working files' or 'Run – Solver' is clicked. The format of this file is given in the Appendix.

6. Properties

Clicking the 'Properties' tab displays this dialog:

	Density	Viscosity	Conductivity
Metal	2300.000	2.609E-7	4100000.
Bath	2100.000	1.571E-6	220.0000
Anode			23300.00
Cathode			90900.00
Cathode collector bars			908000.0
Cathode copper inserts			1.3400E7
Cathode cast iron inserts			645000.0
Anode rods			1.9800E7
Anode stubs			2170000.
Anode cast iron inserts			870000.0
Bus bars			2.8600E7

Units:
 Density - kg/m³
 Viscosity - m²/s
 Conductivity - A/(Vm)

Conductivity ratio for layer adjacent to anodes

The Properties menu allows the density and viscosity of the various fluids in the model to be set. In addition, the electrical conductivity of the various constituents of the electrolysis cell should also be set.

- **Conductivity ratio for layer adjacent to anodes:** sets the amount (as a fraction) by which the conductivity of the bath immediately adjacent to the anode is decreased by. Physically this is modelling the drop in conductivity due to production of gases at the positive terminal in the cell.

7. Models

Clicking the 'Models' tab displays this dialog:

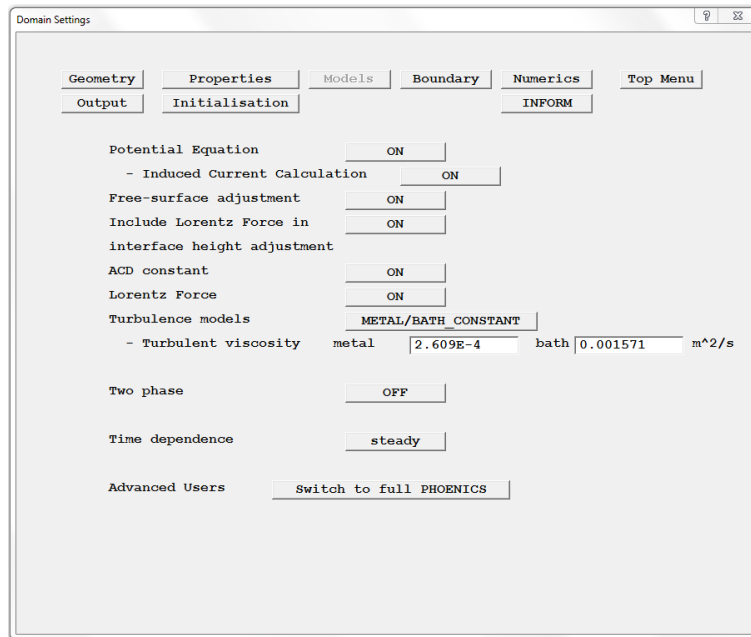

The Models panel allows the user to control the physics that is included in their simulation. It allows them to control which equations are being solved and which terms within them are “turned on”.

In detail:

- **Potential equation:** Solution of the potential equation can be toggled ON or OFF. (Refer to the Appendix for a discussion of the potential equation). The name of the potential equation is EPOT.

The currents in the X, y and Z directions are deduced from the gradients of potential. They are stored as the variables JX, JY and JZ.

- **Induced current calculation:** When set to 'ON', the source terms in the potential equation that arise due to currents created by the motion of charges in the external magnetic field are included. The induced currents are stored as the variables JIX, JIY and JIZ.

When the induced currents are activated, the stored currents JX, JY and JZ are the sum of the induced current and the potential gradient.

- **Free-surface height adjustment:** toggles ON or OFF the height adjustment of the electrolyte free surface. Note however that the metal/bath interface height is ALWAYS adjusted regardless of this setting. The nominal (adjusted) height of the Z cell faces is stored as HI.
- **Include Lorentz force:** When set to ON, the Lorentz forces driving the fluid flow are included in the pressure balance calculation across the interface. When set to OFF only the static pressure differences are included.
- **ACD constant:** The height of the metal-bath interface changes during the simulation. If 'ACD constant' is ON, the height of the anode undersides is adjusted to keep the anode-to-cathode distance fixed. When OFF, the height of the anode undersides remains fixed.

- **Lorentz force:** The Lorentz force arises from the movement of charge through a magnetic field, and it drives the fluid flow in the electrolyte / metal bath. The effect of these forces can be included by toggling Lorentz force ON. By toggling this OFF, the effect of the Lorentz force on the fluid motion is not included. The three components of the Lorentz force are stored as FX, FY and FZ.
- **Turbulence models:** allows the user to select a turbulence model as best suits their application: The options are:
 - Single constant effective turbulent kinematic viscosity for metal and bath zones. (The user may input their desired value in m^2/s).
 - Different constant effective turbulent kinematic viscosities for metal and bath zones. (The user may again input their desired values in m^2/s).
 - Any of the [standard PHOENICS turbulence models](#).
- **Two phase:** The PHOENICS [two-phase capability](#) may be toggled here. This allows modelling of the gas phase that is produced at the anodes. If this is toggled ON, an extra set of equations is solved for the velocity of the gas and its distribution.
- **Time dependence:** switches between steady-state and transient operation. When set to Unsteady, the extra 'Set/Modify time steps' button leads to a [panel](#) where the duration of the transient and the number of time steps can be set.
- **Switch to full PHOENICS:** is included if some additional functionality is needed that falls outside of the options available within the ESTER GUI (such as the solution for energy equations e.g. temperature, enthalpy).

8. Boundary Conditions

Clicking the 'Boundary' tab displays this dialog, shown here in its simplest form:

Domain Settings

Geometry Properties Models **Boundary** Numerics Top Menu

Output Initialisation INFORM

Cathode current distribution

Jz A/m²

Anode potential V Back-EMF V

Initial magnetic field units

Bx = + * X + * Y
+ * X² + * XY + * Y²
+ * X²Y + * XY²

By = + * X + * Y + * X²
+ * XY + * Y²
+ * X²Y + * XY²

Bz = + * X + * Y + * X²
+ * XY + * Y²
+ * X²Y + * XY²

Initial interface height

Initial anode heights

The boundary conditions panel takes one of several forms, depending on whether the collector bars or anode rods or anode busbars are included or not. If there are no collector bars and the anode rod/stub/yoke configuration is 'None', the panel is as shown above.

8.1 Cathode Conditions

- **Cathode current distribution:** This sets the current distribution at the base of the solution domain. This will be the bottom of the cathode blocks if they are included, or the upper surface of the cathode blocks if they are not. The current density in A/m² can either be a constant, or a cell-by-cell value can be read from a file. The format of the file is described in the Appendix.

If the cathode collector bars are included the cathode current setting section changes to this:

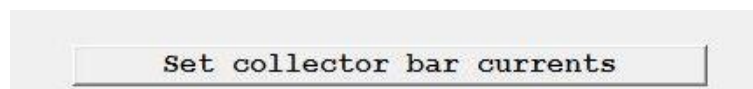

- **Set collector bar currents:** This leads to a dialog from which the current at each end of each collector bar can be set. It is shown below. The remainder of the panel does not change.

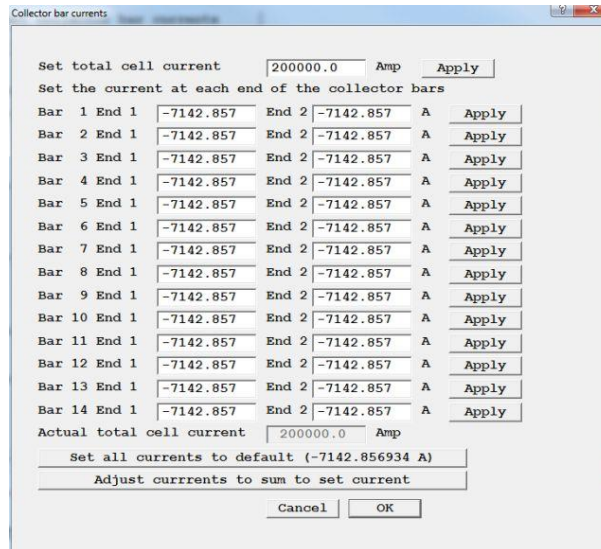

- **Set total cell current:** This sets the target total current through the cell in Amps.
- **Bar 1 End 1 End 2:** These and subsequent input boxes set the current at each end of each collector bar. If there are too many bars to fit on the dialog extra buttons appear which allow the list of collector bars to be scrolled up and down.
- **Actual total cell current:** This displays the actual total current – it is not an input box. It is the sum of all the collector bar currents. Clicking any ‘Apply’ button will update this value using the latest currents.
- **Set all currents to default:** This will reset the current at each end of each collector bar to the target cell current divided by the total number of bar ends. This value is shown in brackets on the button. It will be updated if ‘Apply’ is clicked after entering a new target current.
- **Adjust currents to sum to set current:** This will adjust each current by the ratio of the target total current to the actual total current. The effect is to achieve the target current whilst retaining the relative distribution amongst the bar ends.

If the anode busbars are included, and the total cell current on exit from the dialog is different from that on entry, the opportunity is offered to adjust the busbar currents so that they sum to the new total cell current.

8.2 Anode Conditions

- **Anode potential:** sets the voltage applied at the anodes. If the yokes and rods are not included, the voltage is applied at the upper face of the anode blocks. If they are included, but the busbars are not, the voltage is applied at the top of each anode rod. The input box changes to this button:



The ‘Set anode rod potentials’ button leads to a dialog from which the voltages at each anode rod can be set. It is shown below:

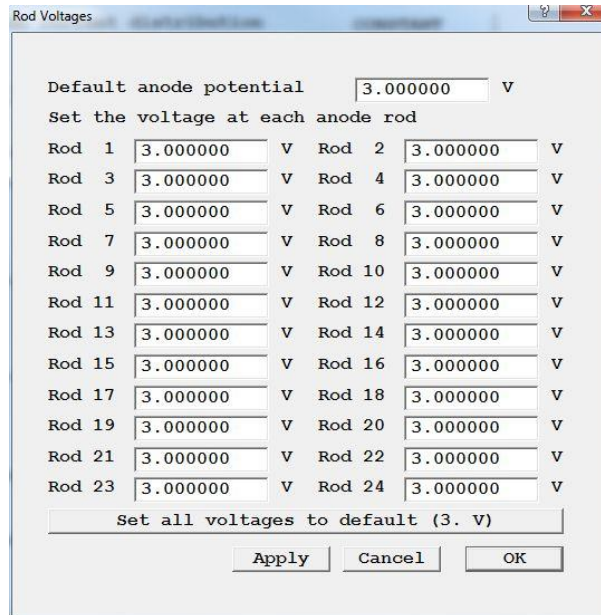

- **Default anode potential:** sets the target anode potential.
- **Rod 1,2 3, etc.:** sets the potential at the top of the selected anode rod.
- **Set all voltages to default:** resets all the voltages to the default value, shown in brackets on the button. If the default potential is changed, clicking 'Apply' will update the value shown.

If the busbars are also included, the anode potential setting line changes yet again to:



The 'Set busbar currents and voltage' button leads to a dialog from which the currents at each busbar current entry-point can be set. It is shown below:

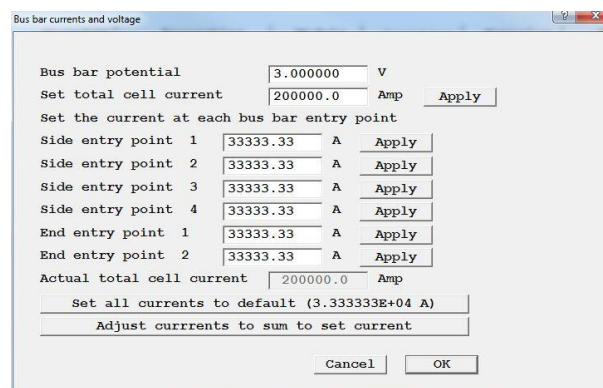

- **Busbar potential:** this sets the potential of the busbar ring. The voltage is applied at the mid-point of the left-most cross-bar.
- **Set total cell current:** this sets the target current through the cell.
- **Side entry point 1,2,3,etc.:** sets the current at the selected side entry-point.
- **End entry point 1,2,3,etc.:** sets the current at the selected side entry-point.
- **Actual total cell current:** This displays the actual total current – it is not an input box. It is the sum of all the entry-point currents. Clicking any 'Apply' button will update this value using the latest currents.

- **Set all currents to default:** This will reset the current at each entry-point to the target cell current divided by the total number of entry-points. This value is shown in brackets on the button. It will be updated if 'Apply' is clicked after entering a new target current.
- **Adjust currents to sum to set current:** This will adjust each current by the ratio of the target total current to the actual total current. The effect is to achieve the target current whilst retaining the relative distribution amongst the entry-points.

If the collector bars are included, and the total cell current on exit from the dialog is different from that on entry, the opportunity is offered to adjust the collector bar currents so that they sum to the new total cell current.

If the collector bars are not included, then on exit the cathode current density is adjusted to the sum of the bus currents divided by the area of the cathode blocks

- **Back EMF:** introduces a potential drop across the anode bath-interface.

8.3 Magnetic Fields

- **Initial magnetic field:** ESTER does not calculate the magnetic field, so values must be supplied. The field can be expressed analytically as a polynomial or linear form, in which case the user specifies the necessary coefficients. (The expansion parameters X, Y are measured from the centre of the cell). Alternatively the magnetic field can be read in from a file. The file format is given in the Appendix. The three components of the magnetic field are stored as BX, BY and BZ.

8.4 Other Settings

- **Units:** ESTER expects the magnetic field to be specified in Tesla. The user-specified field can be in Gauss, Tesla or MilliTesla. The BX, BY and BZ fields seen in the post-processor or in the RESULT file will have been converted to Tesla.
- **Initial interface height:** the height of the metal-electrolyte interface at the start of the calculation can be set in this panel. The options are:
 - flat,
 - constant gradient in x,
 - constant gradient in y or
 - read from a file. The format of the file is given in the Appendix

For the constant-gradient options, additional input boxes appear for the displacement at each end of the cell.

- **Initial anode heights:** the initial heights of the anode undersides can either be flat, or read from a file. The format of the file is given in the Appendix.

It should be noted that all the options relating to 'read from a file' are completely dependent on the number of data entries in the file exactly matching the number of computational cells on an X-Y plane. If the grid is changed, any such files will have to be updated to fit the new grid.

A file called 'grid.txt' containing the cell face locations in each coordinate direction is written whenever 'File – Save working files' or 'Run – Solver' is clicked. The format of this file is given in the Appendix.

9. Numerics

Clicking the 'Numerics' tab displays this dialog:

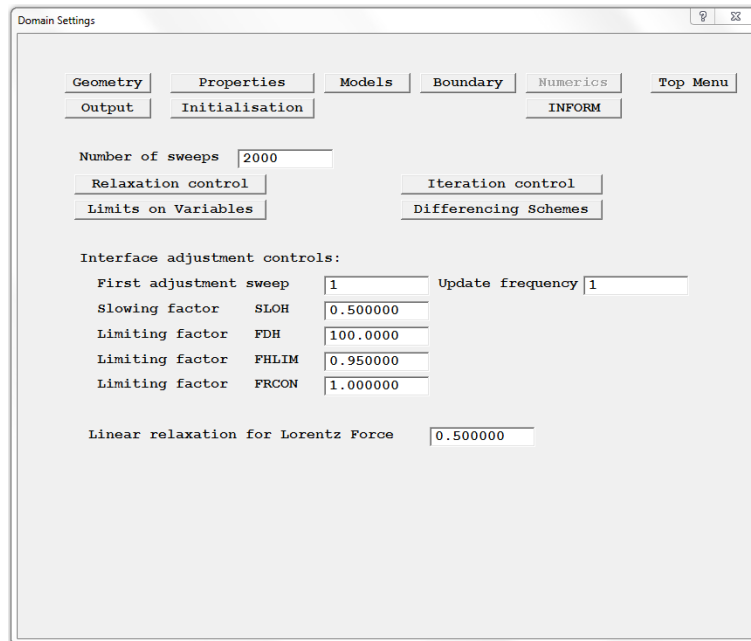

This panel controls the numerical parameters controlling the progress of the solution. The buttons labelled Relaxation control, Iteration control Limits on variables and Differencing schemes are standard PHOENICS features, and are described in [TR326, PHOENICS-VR Reference Guide](#). The remaining options are as follows:

- **Number of sweeps:** this sets the total number of outermost iterations to be performed. For steady cases this may be of the order several thousand for a complicated geometry. For transient cases far fewer sweeps are usually required per time step.
- **First adjustment sweep:** sets the first sweep on which the metal/bath height will be adjusted. The default is to start from the beginning. If there are convergence problems due to the interface going out of control delaying the first adjustment until the flow field has established itself may help.
- **Update frequency:** sets the sweep frequency of the interface height adjustment. The default is to adjust every sweep. If there are convergence problems with the interface going out of control, reducing the frequency to, say, every 10 sweeps can help by allowing the flow field to settle after each adjustment.
- **Slowing factor SLOH:** acts as linear relaxation of the metal/bath height adjustment.
- **Limiting factor FDH:** limits the height adjustment per cycle. It cannot be greater than (nominal metal depth under anodes)/FDH.
- **Limiting factor FHLIM:** controls the minimum and maximum allowed height of the metal/bath interface. It cannot go lower than $(1-FHLIM) \times (\text{nominal metal depth under anodes})$, or higher than $FDHLIM \times (\text{local anode underside height})$.

- **Limiting factor FRCON:** acts to slow down the rate of change of the height of the metal bath interface. (Values >1.0 slow it down).
- **Linear relaxation for Lorentz force:** applies a linear relaxation factor to the sweep-to-sweep change in Lorentz force.

10. ESTER-Specific Output

The **ESTER output** Settings button near the bottom of the Output panel

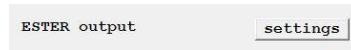

leads to a panel from which various ESTER outputs can be controlled.

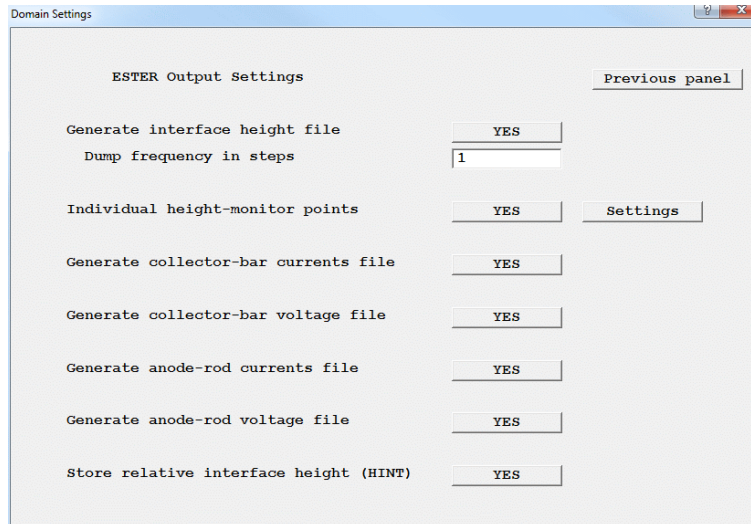

In the above image, all options have been switched on. By default, they are all off.

- **Generate interface height file:** when set to YES, the 2D distribution of the interface height will be written to a file or files. The name of the file will be **hintN.txt** where N is the number of the sweep (or step in transient) at which the file has been written.
- **Dump frequency in sweeps (or steps):** when set to 0, a file will be written at the last sweep in steady or the last step in transient. If set >0, the files will be written with this sweep (or step) frequency. In transient cases, the default is 1, i.e. write each time step.
- **Individual height-monitor points:** when set to YES, the interface height at up to 5 individual locations can be monitored. The 'Settings' button leads to a panel on which the co-ordinates to be monitored can be set:

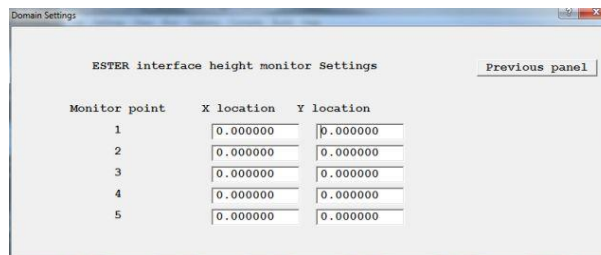

Monitor points with both co-ordinates set to 0.0 are inactive. Each active monitor point will create a file called **hi-mon-N.csv**, where N is the sequence number of the point. In steady state, the file will contain an entry for each sweep. For transient cases it will contain a value for each time-step. The value reported is the interface height in the cell nearest the specified co-ordinate.

- **Generate collector-bar currents file:** This option only appears if the collector-bars are included. When set to YES, files containing the currents at the collector-bar exit points (objects JBAR_nn) will be created each sweep (or each step for transient). Two files are

created, **cbars_1.csv** containing the currents at the low-Y ends of the collector-bars (JBAR_0001, JBAR_0003 etc), and **cbars_2.csv** containing the currents at the high-Y ends (JBAR_0002, JBAR_0004 etc). The values are the total currents in Amps.

- **Generate anode-rod currents file:** This option only appears if anodes are active. When set to YES, files containing the currents at the upper ends of the anode rods (objects VTAB_nn) will be created each sweep (or each step for transient). Two files are created, **rods_j_1.csv** containing the currents in the low-Y anode rods (VTAB_0001, VTAB_0003 etc) and **rods_j_2.csv** containing the currents in the high-Y rods (VTAB-0002, VTAB_0004 etc). The values are the currents in Amps/m² in a cell located nearest the centreline of each rod.
- **Generate anode-rod voltage file:** This option only appears if anodes are active. When set to YES, files containing the voltage at the upper ends of the anode rods (objects VTAB_nn) will be created each sweep (or each step for transient). Two files are created, **rods_v_1.csv** containing the voltage in the low-Y anode rods (VTAB_0001, VTAB_0003 etc) and **rods_v_2.csv** containing the voltage in the high-Y rods (VTAB-0002, VTAB_0004 etc). The values are the voltage in Volts in a cell located nearest the centreline of each rod.
- **Store relative interface height (HINT):** This creates an additional 3D stored variable named HINT which is filled with the distance the interface has moved from it's nominal, flat, position:

HINT = current interface height – nominal interface height

Although it is stored as a 3D variable, HINT is actually the same at each Z location.

11. OBJECT Types Used by ESTER

There is only one object type which is specific to ESTER. This is the ANODE type. All the other elements of the Hall Cell are composed of standard PHOENICS object types. The components of the cell are automatically created from the following objects.

11.1 Anode

Each anode is made using an ANODE type object. The attributes of the ANODE type can be seen by double-clicking an anode on the screen, or in the [Object Management Dialog](#), and then clicking the 'Attributes' button:

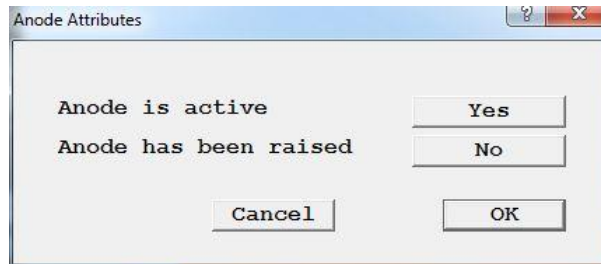

Each individual anode can be de-activated by changing 'Anode is active Yes' to 'No'. In that case, the anode remains in the model but the material is changed from the normal anode carbon to an insulating material.

Each anode can also be raised from its nominal position.

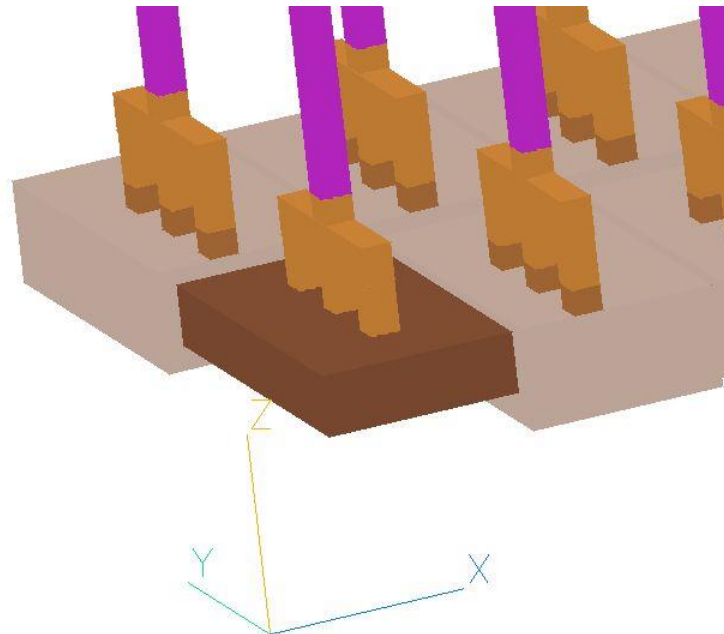

Raised in-active anode

When active, the anode material is set to material number 100. The electrical conductivity of the anode material is set on the Properties panel', Chapter 6. Inactive anodes are set to material 198.

By default, the anodes are rectangular blocks. It is possible to assign other shapes to the individual anodes by opening the Object Specification Dialog for an anode object and then importing a different geometry from the 'Shape' tab.

11.2 Anode Stubs, Yokes, Rods, Bus- and Cross-bars

If the stubs, yokes and rods are not included, the anode voltage condition is set by a USER_DEFINED object called ANOPTNTL, located at the top of the solution domain.

If they are included, the ANOPTNTL object is deleted, and the stubs, yokes etc. are all created using the BLOCKAGE object for the solid parts and the USER_DEFINED object for the current and voltage locations. The following table lists the object types, names and material numbers used. 'nn' refers to an automatically-generated sequence number.

Element	Object type	Name	Material Number
Stub	BLOCKAGE	STUB_nn	105
Yoke	BLOCKAGE	YOKE_nn	105
Rod	BLOCKAGE	ROD_nn	101
Cast iron insert	BLOCKAGE	CAST_nn	108
Bus- and cross bar	BLOCKAGE	BUS_nn	102
Voltage	USER_DEFINED	VOLT_nn	n/a
Current entry	USER_DEFINED	JBUS_nn	n/a

The electrical conductivities of the materials used are set on the Properties panel', Chapter 6.

If the busbars are longer than the metal bath, the spaces at the edges are filled with BLOCKAGE objects named FILL1 and FILL2. These are made of material 198, and do not participate in the solution.

11.3 Cathode Blocks and Collector Bars

If the cathode blocks are not included, or if they are included but the collector bars are not, the cathode current condition is set by a USER_DEFINED object called CATHCURR, located at the base of the solution domain.

If the Cathode blocks and collector bars are included, the CATHCURR object is deleted. The cathode blocks and other components are composed of BLOCKAGE and USER_DEFINED objects, as in the following table.

Element	Object type	Name	Material Number
Cathode block	BLOCKAGE	CATHODn	104
Collector Bar	BLOCKAGE	CBAR_nn	103
Cast iron insert	BLOCKAGE	CAST_nn	107
Copper insert	BLOCKAGE	COPR_nn	106
Current exit	USER_DEFINED	JBAR_nn	n/a

If the cathode blocks do not entirely fill the solution domain in X and / or Y, the spaces at the edges are filled with BLOCKAGE objects named FILLX1/2 and FILLY1/2. These are made of material 198, and do not participate in the solution.

The shape of the cathode blocks can be changed as described in Chapter 4.3.

11.4 Freeze

If the freeze ledge is active, it is represented in the model as four BLOCKAGE objects named FREEZE1 – FREEZE4. These objects are made of material 198 and use the ‘wedge’ geometry.

11.5 Other Objects

The other objects which may be found in an ESTER case include:

Name	Type	Function
INIAIR	BLOCKAGE, material 199	Create air-space above electrolyte
INIELEC	BLOCKAGE, material 52	Crates electrolyte bath
PREF1	CELLTYPE	Fixed pressure point in metal layer
PREF2	CELLTYPE	Fixed pressure point in electrolyte layer
FLOOR	PLATE	Friction condition at Z=0.0
XMIN / XMAX	PLATE	Friction condition at X=0.0 and X=Xmax
YMIN / YMAX	PLATE	Friction condition at Y=0.0 and Y=Ymax
INTERFAC	NULL	Create Z grid region at metal / bath interface
FREESURF	NULL	Create Z grid region at bath free surface
VTAB_nn	USER_DEFINED	Tabulate voltage and current at top of anode rod

The metal layer is treated as the domain material, with material number 51.

The air space is treated as a non-participating zone – there is no solution there.

12. Post Processing

The main Post Processor for ESTER is the standard PHOENICS VR-Viewer. This is described in some detail in [TR326, PHOENICS-VR Reference Guide](#). Only a few items of specific interest to ESTER are described here.

It may be helpful to switch the display to wire-frame mode by clicking the wireframe toggle . The user should be familiar with plotting [contours](#), [vectors](#) and [iso-surfaces](#).

12.1 Displaying the metal - electrolyte interface

There are several ways to display the metal – electrolyte interface. One way is to plot a contour map of the variable HI. Switch the plotting plane to Z and move the probe to the plane immediately below the interface. Select HI as the plotting variable, and turn on the contour display by clicking the contour icon . Right-click this icon, and increase the minimum value until the first white space appears in the blue zone, then decrease a fraction until it disappears. Decrease the maximum value until the first white space appears in the red zone, then increase a fraction. The contour map should now be scaled to the minimum and maximum heights of the interface.

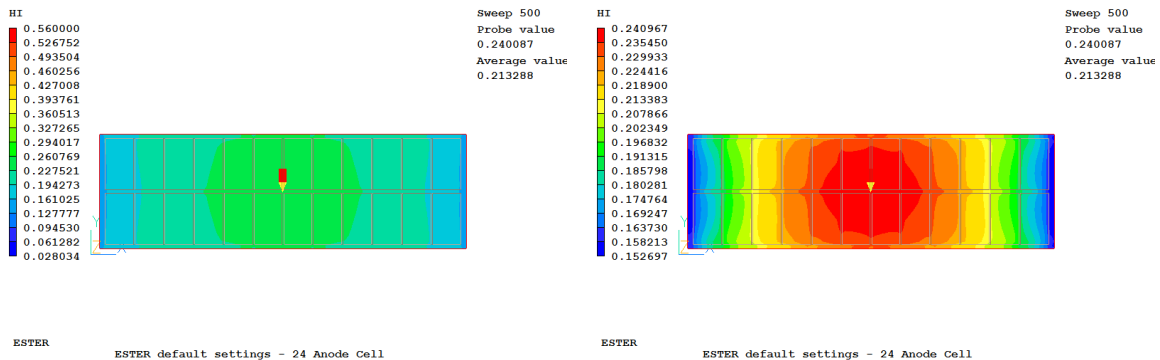

Original scale

Adjusted scale

Another way to display the interface is to draw an iso-surface of the variable SURF. This variable has a value of 1.0 in the metal and 0.0 in the electrolyte. In the cell containing the interface, it is set to $(\text{interface height} - \text{lower Z face height}) / (\text{Z width of cell})$. Thus an iso-surface with value 0.5 will show a 3D image of the interface shape.

A short-cut method of creating this iso-surface has been provided by means of a macro.

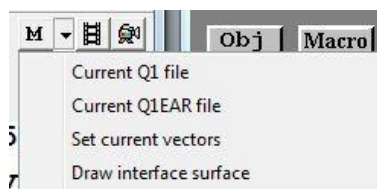

On the menu bar, click the down-arrow next to M, as shown above. Clicking on 'Draw interface surface' will cause the interface to be drawn.

The interface deformations tend to be very slight and this hard to see. It can help to stretch the domain in Z in order to exaggerate the deformation. On the menu bar click 'Settings' then 'Editor parameters'. Set the Z scale to, say, 5, to graphically stretch the domain by that factor.

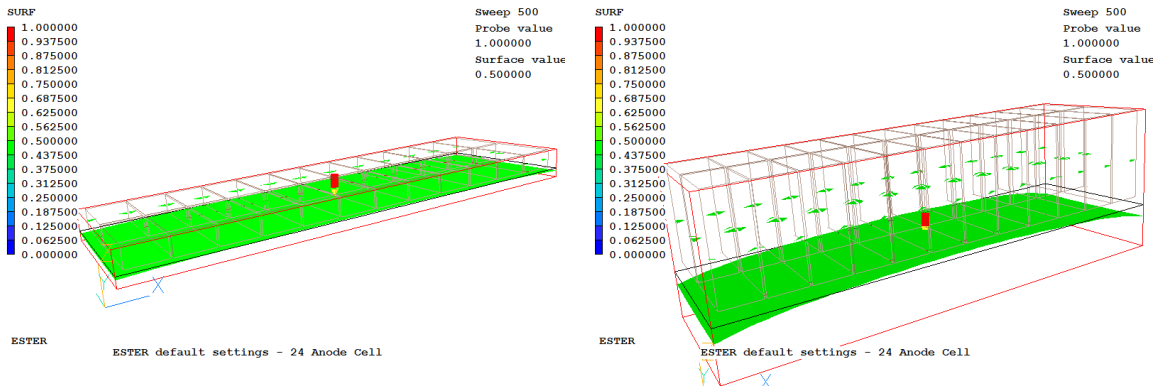



Actual proportions

Z scale increased by factor 5

To switch the iso-surface off, click the iso-surface icon .

Yet another way is to plot contours of the additional variable HINT

12.2 Plotting vectors of current

To plot vectors of the electric current, the vector components must be set to the currents, JX, JY and JZ. A macro to do this has been provided. On the macro menu shown on the previous page, select 'Set current vectors'. When the vectors are now displayed by clicking on the vector toggle  they will be based on the currents. Selecting  as the display variable will colour the vectors by the magnitude of the current.

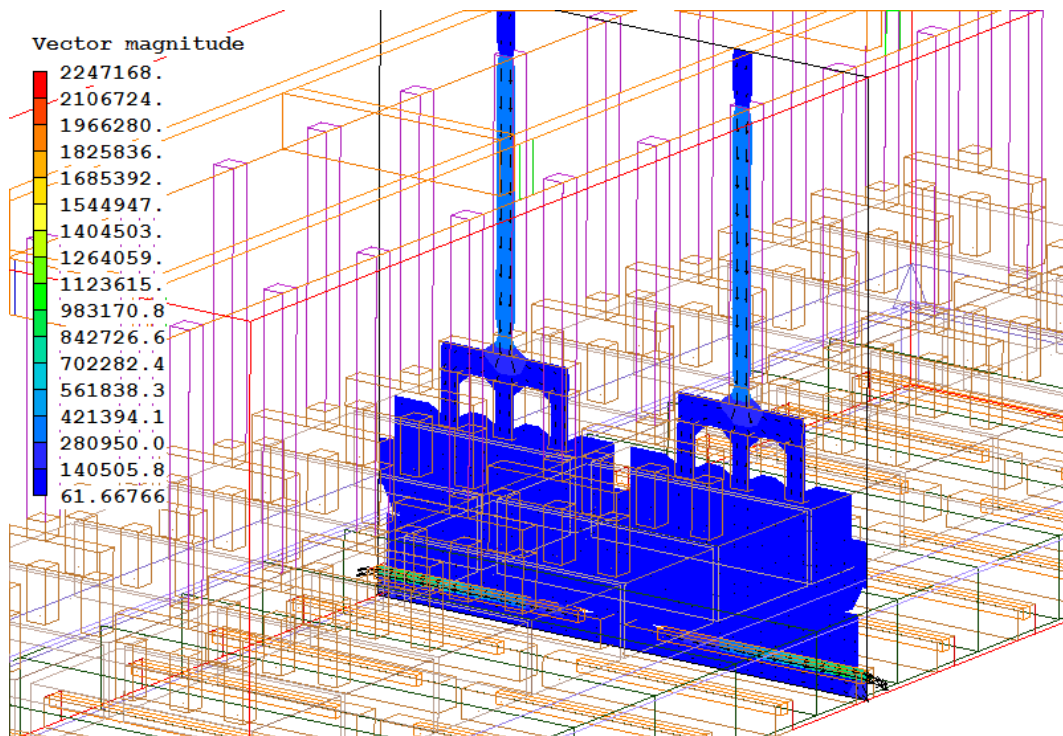

Current vectors coloured by total current

12.3 Plotting vectors of other vector quantities

To plot vectors of any other quantity, such as the Lorentz force or the magnetic field, the vector components must be set to the appropriate variables. This action is performed on the 'Vectors' tab of the 'Viewer Options' dialog. This can be reached by right-clicking the vector toggle, to display this dialog:

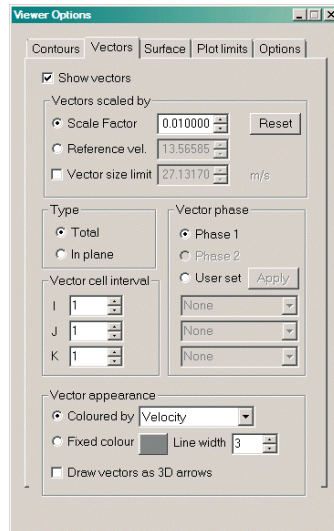

Switch the 'vector phase' to 'User set', then select the required vector component variables. Finally click 'Apply' to regenerate the vectors and vector magnitude field.

12.4 Creating Animations

In a transient case, any image can be animated by clicking the 'Run animation' icon . This will regenerate the current image from each stored data set in turn. The animation can be captured as an AVI or animated GIF. Options for saving the animation can be found by right-clicking the icon.

Note that by default the contour range and vector scale for each time step will be reset to the full range for that step. This may result in in-consistent colours or vector lengths during the animation. To prevent this, explicitly set a minimum and maximum range for the contours (different from identically the full range), and set the vector scaling to 'Reference velocity' and input an explicit reference value. These will remain constant during the animation.

12.5 Monitoring Rod Voltage and Current

Once the anode stubs / yokes / rods have been activated, a monitoring location is created at the top of each anode rod. These have the name VTAB_nnnn where nnnn is the sequence number of the rod.

As described in 10 ESTER-specific output, the output from these monitor objects is a series of files with names 'rods_j_n.csv' and 'rods_v_n.csv' where n is 1 for odd-numbered rods and 2 for even numbered rods. For a steady case the files contain the Z-current (JZ) and potential (EPOT) respectively at the cell nearest the middle of the rod for each sweep (iteration). In a transient case the values are written at the end of each time step.



The '.csv' extension (Comma-Separated Values) means that the files are directly compatible with Excel and also the Autoplot table format.

12.6 Monitoring Collector-bar currents

As described in 10 ESTER-Specific Output, the current drawn from each end of each collector bar can be monitored in the file 'cbars_1.csv' for odd-numbered exit points, and 'cbars_2.csv' for even-numbered exit points.

12.7 Monitoring the Interface Height

There are three independent means of monitoring the evolution of the interface height with sweep for steady cases or with step for transient cases.

- As described in 12.1 Displaying the metal-electrolyte interface, create an iso surface of the interface. Click the Animate' button  to redraw the image from each saved set of results. As long as the sweep/step frequency of dumping on the 'Field dumping – settings' panel of the Main Menu Output panel is set >0, this will produce an animation of the interface height motion.
- As described in 10 ESTER-Specific Output, activate the generation of interface-height files every n sweeps or steps. Display the interface height maps in 3rd party software.
- As described in 10 ESTER-Specific Output, activate up to 5 interface-height monitor points. Display the change of interface height at these locations in Excel or Autoplot.
- As described in 10 ESTER-Specific Output, activate storage of the relative interface height HINT. Create a contour map at any Z location (they are all the same), then click the Animate' button  to redraw the image from each saved set of results. As long as the sweep/step frequency of dumping on the 'Field dumping – settings' panel of the Main Menu Output panel is set >0, this will produce an animation of the interface height motion.

13. Q1 Settings

The Q1 settings for a case with anodes, stubs, busbars, cathode blocks, collector bars and cast-iron inserts is shown here. If an item is set to NO, then the subsequent data settings will be absent.

13.1 Domain Settings

The carbon blocks are included:

```
> DOM, CARBON-BLOCKS, YES
```

The name of the default geometry file

```
> DOM, CATHODE-GEOM, default
```

The number of cathode blocks

```
> DOM, NUM-BLOCKS, 14
```

The block size in X, Y and Z

```
> DOM, BLOCK-SIZE, 7.030000E-01, 3.000000E+00, 4.500000E-01
```

The collector bars are included

```
> DOM, COLLECTOR-BAR, YES
```

The number of collector bars per cathode block

```
> DOM, NUM-BARS, 1
```

The size of the collector bars in X, Y and the central gap

```
> DOM, BAR-SIZE, 1.500000E-01, 1.600000E-01, 2.000000E-01
```

The copper inserts are included

```
> DOM, COPPER-INSERT, YES
```

The copper insert size in X, Y and Z and the edge offset

```
> DOM, INSERT-SIZE, 5.000000E-02, 1.300000E+00, 6.000000E-02, 1.000000E-01
```

The cast-iron inserts around the collector bars are included

```
> DOM, CAST-IRON-INS, YES
```

The thickness of the inserts

```
> DOM, INSERT-THICK, 5.000000E-03
```

The anodes are included

```
> DOM, ANODES, YES
```

The number of anodes in X and Y

```
> DOM, NUM-ANODES, 12, 2
```

The size of the anode, the edge gap and inter-anode gap in X then Y

```
> DOM, SIZE-X, 7.700000E-01, 4.000000E-02, 1.600000E-01
```

```
> DOM, SIZE-Y, 1.400000E+00, 1.000000E-01, 1.000000E-01
```

The depth of metal and anode height

```
> DOM, SIZE-Z-1, 2.000000E-01, 4.000000E-01
```

The depth of electrolyte and ACD

```
> DOM, SIZE-Z-2, 2.000000E-01, 4.000000E-02
```

The tapping gaps are included in X, gap size, number of cells in gap, after anode(s)

```
> DOM, TAPPING-GAP, YES, X, 1.000000E-01, 1, 6, 7
```

The anode yoke configuration

```
> DOM, YOKE-CONFIG, 1*3
```

The anode stub diameter, depth of insertion into anode and distance from top of carbon to top of yoke

```
> DOM, ANODE-STUB, 1.300000E-01, 1.000000E-01, 3.500000E-01
```

Size of yoke in X, Y and Z

```
> DOM, ANODE-YOKE, 1.200000E-01, 8.100000E-01, 1.500000E-01
```

Size of anode rod in X, Y and Z, and length of steel at end of rod

```
> DOM, ANODE-ROD, 1.200000E-01, 1.200000E-01, 1.500000E+00, 1.000000E-01
```

The cast-iron inserts around the anode stubs are included

```
> DOM, STUB-LAYER, YES
```

The layer thickness

```
> DOM, LAYER-SIZE, 5.000000E-03
```

The busbars are included

```
> DOM, BUSBARS, YES
```

The number of busbars (in Y), the number of cross bars (in X), the number of side current entry-points and the number of end current entry-points

```
> DOM, NUM-BUSBARS, 2, 4, 4, 2
```

The busbar size in X, Y and Z

```
> DOM, BUS-SIZE, 9.680000E+00, 1.200000E-01, 3.000000E-01
```

The size of each cross bar in X and the centre location in X relative to the busbar origin, repeated for each cross bar where n is the sequence number of the cross bar

```
> DOM, BAR-SIZE-0n, 1.200000E-01, 5.999994E-02
```

The size of each side current entry-point in X and the centre location in X relative to the busbar origin, repeated for each side entry where n is the sequence number of the entry-point

```
> DOM, SIDE-ENTRY-0n, 1.200000E-01, 5.999994E-02
```

The size of each end current entry-point in Y and the centre location in Y relative to the busbar origin, repeated for each end entry where n is the sequence number of the entry-point

```
> DOM, END-ENTRY-0n, 1.200000E-01, 5.999994E-02, 0
```

The number of cells in the anode, edge gaps and interanode gaps in X then in Y

```
> DOM, NUM-X, 10, 2, 2
```

```
> DOM, NUM-Y, 16, 2, 2
```

The number of Z cells below the copper inserts, in the copper inserts and collector bar above the copper.

```
> DOM, NUM-Z-1, 2, 2, 5
```

The number of Z cells in the electrolyte, metal below the anodes, metal at anode immersion, and anodes above the bath

```
> DOM, NUM-Z-2, 5, 3, 4, 3
```

The number of Z cells in the yoke, rod and busbars

```
> DOM, NUM-Z-3, 5, 10, 2
```

The freeze ledge is included

```
> DOM, FREEZE, YES
```

The freeze-toe to anode edge distance

```
> DOM, FREEZE-TOE, 0.000000E+00
```

The Lorentz forces are ON

```
> DOM,      LORENTZ,      ON
```

ESTER auto-meshing is ON

```
> DOM,      AUTOMESH,      ON
```

The interface is initially flat

```
> DOM,      INTERFACE,      FLAT
```

The alternative settings are `SLOPE_IN_X`, `SLOPE_IN_Y` or `READ_FROM_FILE`. The initial displacements at either end are then held in `RG(16)` and `RG(17)`. The file name is held in `SPDAT(SET,ESTER,HUMP,C,file_name)`

The total cell current in Amps

```
> DOM,      CELL-CURRENT,  2.000000E+05
```

13.2 Variables Passed to ESTRGR

In addition, many values are passed to the ESTER Ground station using the `LG`, `IG` and `RG` arrays. The following table lists the default values of these variables and their meanings. The variable names used for some variables in earlier versions of ESTER are given in brackets.

Variable Name	Function
LG(1) = T	Induced current calculation active
LG(2) = T	Free surface adjustment active
LG(3) = T	Include Loretz force in interface adjustment
LG(4) = T	ACD constant
IG(1) = 14	Last IZ plane in metal (IZ1)
IG(2) = 17	IZ plane under anodes (IZ2)
IG(3) = 1	Interface height adjustment frequency (NIH)
IG(4) = 1	First sweep for interface adjustment (IHF)
IG(6) = 21	Last IZ plane in air space above bath (IZ3)
IG(11)=0	If >0, read height of anode undersides from file – see Appendix B (HANO)
IG(12)=0	If >0, read initial interface height distribution from file – see Appendix D (HUMP)
IG(13) = 9	Last IZ plane in cathode block (IZ0)
IG(14) = 2	Magnetic field units flag (0-Tesla, 1-Gauss, 2-milliTesla) (IMAGU)
IG(15) = 1	Magnetic field formula switch (0-linear, 1-polynomial) (IMAGF)
RG(1) =2300.	Density of metal (RHOMET)
RG(2) =2100.	Density of electrolyte (RHOELC)

RG(3) =1.	Density of anode (RHOANO)
RG(4) =4.1E+06	Electrical conductivity of metal (CONMET)
RG(5) =220.	Electrical conductivity of electrolyte (CONELC)
RG(6) =2.33E+04	Electrical conductivity of anode (CONANO)
RG(7) =-9.81	Gravitational acceleration (AGRAVZ)
RG(9) =-7096.	Cathode current density (negative – value in A/m ² , positive - read from file) (JZCATH)
RG(11) =0.5	Slowing factor (SLOH)
RG(12) =100.	Limiting factor (FDH)
RG(13) =0.9999	Limiting factor (FHLIM)
RG(14) =1.	Limiting factor (FRCON)
RG(15) =0.5	Linear relaxation factor for Lorentz Force (RELF)
RG(16)=0.	Initial displacement of interface at X or Y = 0
RG(17)=0.	Initial displacement of interface at X or Y = max
RG(18) =2.608696E-07	Laminar kinematic viscosity of metal (ENUMET)
RG(19) =1.571429E-06	laminar kinematic viscosity of electrolyte (ENUELC)
RG(22) =3.	Anode potential in Volts (ANOPOT)
RG(23) =1.189	Density of air (RHOAIR)
RG(29) =1.	Conductivity ratio for layer adjacent to anodes (CONFAC)
RG(31) =9.09E+04	Electrical conductivity of cathode
RG(32) =7000.	Density of cathode
RG(33) =7800.	Density of collector bar
RG(34) =9.08E+05	Electrical conductivity of collector bar
RG(35) =2700.	Density of anode rod
RG(36) =1.98E+07	Electrical conductivity of anode rod
RG(37) =2700.	Density of busbar
RG(38) =2.86E+07	Electrical conductivity of busbar
RG(40 – 67)	Constants in polynomial expression for BX, BY and BZ (AA0-AA7, BB0-BB7, CC0-CC7)
RG(42) =12.903	Constant AA2

RG(46) =-0.465	Constant AA6
RG(51) =-4.	Constant BB1
RG(57) =0.832	Constant BB7
RG(64) =-1.032	Constant CC4
RG(71) =7800.	Density of anode stub
RG(72) =2.17E+06	Electrical conductivity of anode stub
RG(73) =8950.	Density of copper insert
RG(74) =1.34E+07	Electrical conductivity of copper insert
RG(75) =7800.	Density of cast iron insert in anode
RG(76) =6.45E+05	Electrical conductivity of cast iron insert in anode
RG(77) =7800.	Density of cast iron insert in cathode
RG(78) =8.7E+05	Electrical conductivity of cast iron insert in cathode

13.3 Anode Object

The specific settings for an anode object are:

Set object type to ANODE

```
> OBJ, TYPE, ANODE
```

Anode is not active – (line not written for active anodes)

```
> OBJ, ACTIVE, NO
```

Anode is raised by n cells – (line not written for un-raised anodes)

```
> OBJ, RAISED, YES, n
```

The material of an ANODE object is always set to 100.

13.4 Additional Monitoring flags

Generate interface height file:

```
SPEDAT (SET, ESTER, HI-FILE, C, YES)
```

Interface-height file dumping frequency:

```
SPEDAT (SET, ESTER, HI-FREQ, I, ifreq)
```

Individual height-monitor plots active:

```
SPEDAT (SET, ESTER, HI-MON, C, YES)
```

Height-monitor locations:

```
SPEDAT (SET, ESTER, HI-MON-X-n, R, Xcoord)
```

```
SPEDAT (SET, ESTER, HI-MON-Y-n, R, Ycoord)
```

Generate collector-bar currents file:

```
SPEDAT (SET, ESTER, CBARJ-FILE, C, YES)
```

Generate anode-rods currents file:

SPEDAT (SET, ESTER, RODSJ-FILE, C, YES)

Generate anode-rods voltage file:

SPEDAT (SET, ESTER, RODSV-FILE, C, YES)

Appendix A. Mathematical Background

A.1 Some notes on the solution of the General Conservation Equation

PHOENICS solves a general conservation equation, which for a single phase flow may be written as:

$$\frac{\partial(\rho\phi)}{\partial t} + \nabla(\rho u\phi - \Gamma_\phi \nabla\phi) = S_\phi$$

Where the symbols are as defined below:

ϕ	-	The conserved quantity in question (e.g. momentum, energy, mass etc.)
ρ	-	Density
u	--	Velocity vector
Γ_ϕ	-	Diffusive exchange coefficient
S_ϕ	-	Source term

The source term and exchange coefficient vary from equation to equation, and also from case to case. Examples of source term are pressure gradient and gravity force for the momentum equations, or kinetic heating for the enthalpy equation. The mass continuity equation can also be written in the above form by setting $\phi=1$ and $\Gamma_\phi=0$.

The commonly appearing sources, such as those mentioned above, are pre-programmed into the PHOENICS solver, EARTH. Provision is then made to enable users to add in any further sources required.

The partial differential equation above is integrated over 'control volumes' (cells) to form the Finite Volume Equation that is actually solved. The linkage between velocity, pressure and continuity is resolved by a variant of the SIMPLE algorithm.

A.2 Momentum Sources

In a Hall Cell, the flow is primarily driven by the Lorentz forces. These are added to the standard momentum equations through the ESTER Ground station. The Lorentz forces are computed from the cross product of the electric current J and the magnetic field B ,

$$F = J \times B$$

Or explicitly writing the cross product in terms of x y and z components, this becomes:

$$F_x = J_y B_z - J_z B_y$$

$$F_y = J_z B_x - J_x B_z$$

$$F_z = J_x B_y - J_y B_x$$

These forces are then applied to the momentum equations as source terms. Laminar or turbulent friction is applied at the cathode, and on the anode undersides.

A.3 The Potential Equation and Current Calculations

The potential equation is obtained from the standard conservation equation by removing the built-in sources, and convective and transient terms. The remaining, diffusive, term then contains the electrical conductivity.

Finally, the currents are deduced in the ESTER Ground station as the gradients of the electric potential:

$$J = -\sigma \nabla E$$

In terms of components, this is:

$$J_x = -\sigma(E_e - E_p)/\delta X_g$$

$$J_y = -\sigma(E_n - E_p)/\delta Y_g$$

$$J_z = -\sigma(E_h - E_p)/\delta Z_g$$

Where: X_g , Y_g and Z_g are the distances between cell centres in the x, y and z directions.

In addition, the induced currents arising from the motion of the liquid through the magnetic field are calculated from:

$$J_i = \sigma(V \times B)$$

In terms of x y and z components, this is:

$$J_{ix} = \sigma(VB_z - WB_y)$$

$$J_{iy} = \sigma(WB_x - UB_z)$$

$$J_{iz} = \sigma(UB_y - VB_x)$$

The total current is then $J + J_i$. (The calculation of J_i is controlled by the variable LG(1). When set to T, the induced currents are calculated, when left at F, they are not).

The potential, being a scalar, is stored at the cell centres. The currents, being components of a vector, are stored at the cell faces. This results in complications at the Lorentz force stage, as none of the currents is stored at a convenient location. Hence in the calculation of the Lorentz force, for each current component four currents must be averaged to the relevant cell face, taking into account non-uniformities of the grid.

A.4 Potential Equation Sources

The boundary conditions for the potential equation are:

- Fixed current at the cathode; and,
- Fixed potential at the anode.

This is equivalent to fixed mass flux and fixed pressure respectively.

The cathode current can either be set to a constant value, or a distribution can be read in from a file containing cell by cell values over the cathode. It is left to the user to specify these values appropriately. The values should be specified in Amps/m².

Note that if freeze is present, the cathode currents under the freeze should be set to zero. The freeze is a very poor conductor, and huge potentials will result. These may lead to numerical overflow.

If the collector bars are **not** included, the setting of cathode current is controlled by the variable JZCATH (RG(9)) in Q1. This was always the practice in previous versions of ESTER.

The variable can take the following values:

JZCATH < 0 - cathode current density set to uniform value of JZCATH.

JZCATH > 0 - cathode current densities read in from file CG(2) attached to logical unit JZCATH.

If CG(2) is set to Q1, the data can be included in Q1, starting in column 3 or more. The start of the data is marked with *JZC in column 3. CG(2) can only be 4 characters long. To use a file name up to 30 characters long, the file name can be set as SPEDAT(SET,ESTER,JZCATH,C,file_name).

A USER_DEFINED object named CATHCURR is created at the base of the domain. The object has a related PATCH command which sets the current:

```
This patch is attached to object CATHCURR
PATCH(CATHCURR, LOW, -1, 0, 0, 0, 0, 0, 1, 1)
COVAL(CATHCURR, EPOT, FIXFLU, GRND)
```

If the collector bars **are** included, the above settings are not used. In this case, the CATHCURR object and CATHCUR patch are deleted. A USER_DEFINED object named JBAR_nn is created at each end of each collector bar. Each such object has an associated PATCH which sets the current density. The current density at each end of a bar is calculated from the bar current divided by the cross-sectional area of the collector bar.

If the collector bars are **not** included, but the busbars **are** included, the value of JZCATH is deduced from the total cell current divided by the combined area of the cathode blocks (or the freeze-free plan area of the domain if the cathode blocks are not included).

If the yokes, stubs, rods and busbars are **not** included, the anode potential is set to a single constant value in all anodes. This is done in the subroutine POTENT, which is supplied as a model. If the user wishes to update anode potentials, then POTENT can be used as a 'junction box', to interface to some other software suite which would supply the potentials.

A USER_DEFINED object called ANOPTNTL is created at the top of the domain. A related patch ANOPTNT then sets the potential:

```
This patch is attached to object ANOPTNTL
PATCH(ANOPTNT, HIGH, -1, 0, 0, 0, 0, 0, 1, 1)
COVAL(ANOPTNT, EPOT, GRND, GRND)
```

The potential is set at the centre of the high face of the top slab of the domain for those cells containing anode material. The anode potential is held in RG(22) in Q1.

If the anode yokes, stubs and rods **are** included, the ANOPTNTL object and associated ANOPTNT patch are deleted. A USER_DEFINED object named VOLT_nn is created at the top of each anode rod, and an associated patch fixes the potential to the rod potential.

Further, if the busbars are also included, then a USER_DEFINED object called JBUS_nn is created at each current-entry location, and a fixed-current condition is set by an associated patch. The current is deduced from the entry-point current divided by the cross-sectional area of the entry-point. In addition, a single fixed-potential condition is applied at the midpoint of the left-most (in X) cross bar. This is done by a USER_DEFINED object called VOLT_nn and associated patch.

A further source for the potential equation arises from the induced currents. This source takes the form:

$$S = \nabla J_i$$

This is written in finite-difference form as:

$$S = (A_n J_{iy})_p - (A_n J_{iy})_s + (A_e J_{ix})_p - (A_e J_{ix})_w + (A_h J_{iz})_p - (A_h J_{iz})_l$$

where the subscript 'p' denotes the current cell, and 'w','s','l' denote the neighbours in the low x, low y and low z directions. A_e , A_n and A_h are the cell face areas.

If the induced currents are not calculated, i.e. LG(1)=F, the source is set to zero.

A.5 Magnetic Fields

To avoid the interpolation complications associated with the current components, the B field components are deemed to be stored at the cell centres, even though they too are strictly vectors.

The values of B_x , B_y and B_z can either be calculated from simple algebraic expressions, or individual cell values can be read in from a data file. The fields can be specified in Gauss, Tesla or milliTesla. Internally, the values are always converted to Tesla.

The expressions used are a linear formula:

$$B_x = A_0 (1 - 2Y/Y_{max})$$

$$B_y = B_0 (1 - 2X/X_{max})$$

$$B_z = C_0 (1 - 2X/X_{max}) (1 - 2Y/Y_{max})$$

or a polynomial formula:

$$B_x = A_0 + A_1 X + A_2 Y + A_3 X^2 + A_4 XY + A_5 Y^2 + A_6 X^2Y + A_7 XY^2$$

$$B_y = B_0 + B_1 X + B_2 Y + B_3 X^2 + B_4 XY + B_5 Y^2 + B_6 X^2Y + B_7 XY^2$$

$$B_z = C_0 + C_1 X + C_2 Y + C_3 X^2 + C_4 XY + C_5 Y^2 + C_6 X^2Y + C_7 XY^2$$

The coefficients $A_0 - A_7$ are held as RG(40) – RG(47) in Q1.

The coefficients $B_0 - B_7$ are held as RG(50) – RG(57) in Q1.

The coefficients $C_0 - C_7$ are held as RG(60) – RG(67) in Q1.

There is at present no provision for updating the B field, but this can easily be done from Group 19 of the Ground station, if a suitable physical mechanism is known.

The setting of the B field is controlled by the variable MAGF (IG(5) in Q1). This can take the following values:

MAGF = 0 - B fields calculated from algebraic expressions in Group 11 of the ESTER Ground station.

MAGF > 0 - B fields read in from file CG(1) attached to logical unit MAGF.

If CG(1) is set to Q1, the data can be included in Q1, starting in column 3 or more. The start of the data is marked with *MAGF in column 3.

CG(1) can only be 4 characters long. To use a file name up to 30 characters long, the file name can be set as SPEDAT(SET,ESTER,MAGF,C,file_name).

Appendix B. Location of Anodes

In the original version of ESTER the locations of the anodes were read in from a data file. The file contains a 0 or a 1 for each cell on a slab. Zero means no anode, one means anode present for $Iz > Iz2$ up to $Iz = Nz$. These settings are now converted into ANODE objects.

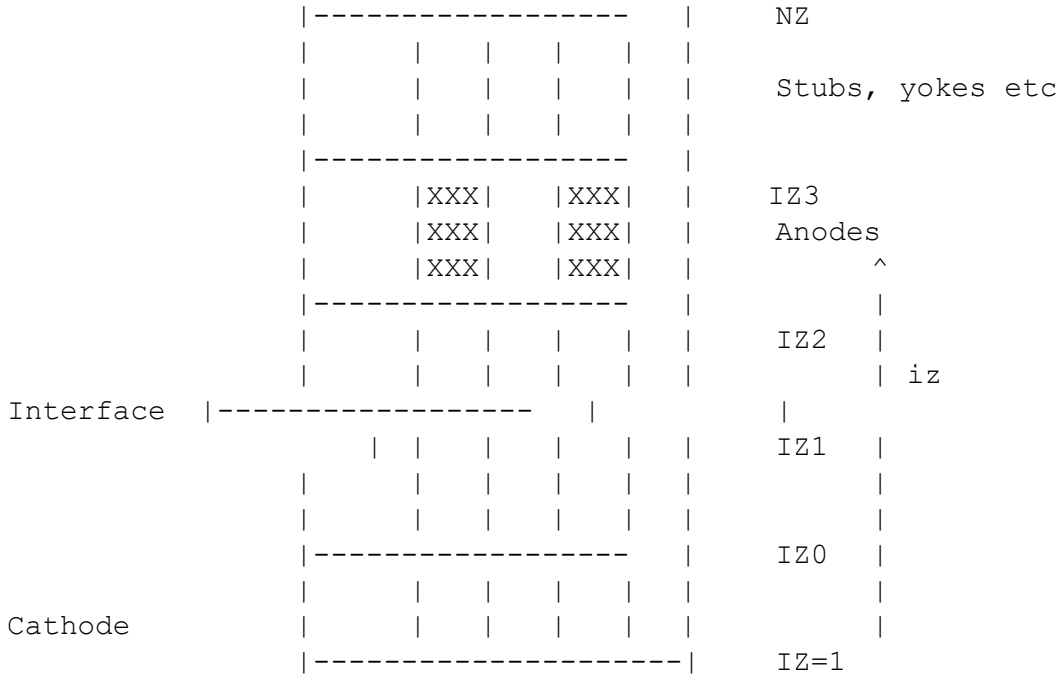

$Iz0$ (IG(13) in Q1) denotes the last slab in the cathode blocks. If they are not included, $Iz0=0$. $Iz1$ (IG(1) in Q1) denotes the slab immediately under the metal-electrolyte interface, $Iz2$ (IG(2) in Q1) denotes the slab immediately under the anodes, and $Iz3$ (IG(6) in Q1) denotes the slab immediately under the electrolyte-air interface.

The setting of these flags ($Iz0 - Iz3$) is deduced internally from the geometrical set up and the meshing.

All velocities are set to zero inside the anodes and above, and the pressure is set to zero. Only the potential equation is solved inside and above the anodes.

The reading of the file is controlled by the variable IANO (IG(10) in Q1). This can take the following values:

- IANO = 0 - No anodes present.
 - IANO > 0 - Read anode locations from file CG(4) attached to logical unit IANO.
- If CG(4) is set to Q1, the data can be included in Q1, starting in column 3 or more. The start of the data is marked with *IANO in column 3.

Note that this method of locating the anodes is no longer supported by the ESTER GUI. If an old pre-GUI Q1 containing these settings is read, they will be translated into ANODE objects.

The underside of the anodes, i.e. the high faces of slab $Iz = Iz2$, may be flat, or a non-uniform distribution may be read in from a data file.

The reading of the file is controlled by the variable HANO (IG(11) in Q1). This can take the following values:

- HANO = 0 - Anode undersides are flat.

HANO > 0 - Read anode underside heights from file CG(5) attached to logical unit HANO.

If CG(5) is set to Q1, the data can be included in Q1, starting in column 3 or more. The start of the data is marked with *HANO in column 3.

CG(5) can only be 4 characters long. To use a file name up to 30 characters long, the file name can be set as SPEDAT(SET,ESTER,HANO,C,file_name).

Under some circumstances, the anode undersides may take on the shape of the metal-electrolyte interface. This situation, known as 'burn-off', may be modelled by setting LG(4) = T. The distance between the anodes and the interface will now be kept constant at the initial value irrespective of the motion of the interface.

Appendix C. Freeze

The freeze is the solid accretion around the edges of the cell, which reduces the volume and the available cathode area. The presence of freeze is accounted for by fixing the velocities and pressure to zero in selected cells. The potential is also fixed to zero within the freeze, as it is such a poor conductor.

The location and height of the freeze was read in from a data file. The file contained the height, in full Z slabs, of freeze in each column of cells. The freeze may extend up into the electrolyte layer.

The reading of the file was controlled by the variable IFRZ. This can take the following values:

IFRZ = 0 - No freeze present.

IFRZ > 0 - Read freeze heights from file CG(3) attached to logical unit IFRZ.

If CG(3) is set to Q1, the data can be included in Q1, starting in column 3 or more. The start of the data is marked with *IFRZ in column 3.

Note that this method of locating the freeze is no longer supported by the ESTER GUI. If an old pre-GUI Q1 containing these settings is read, they will be translated into blockage objects.

The modelling of the freeze was very simple - no partial cell occupation is allowed, and freeze will rise and fall with the interface, as the height is specified in terms of slabs, not actual height.

In the current ESTER, the freeze ledges are modelled as sloped non-conductive blockages at the domain edges.

Appendix D. The Moving Grid and the Metal-Electrolyte Interface

As discussed in the introduction, the primary feature of the Hall Cell is the presence of two distinct layers of fluid, which never mix. Lorentz forces deform the interface between these two layers of fluid and the enormous difference in conductivity across them means that even small height fluctuations can significantly alter the resistance paths, and hence current distributions. This then feeds back to the Lorentz forces and the height distribution.

In ESTER, the interface is always maintained at the high faces of the slab $IZ = IZ1$. The grid is then stretched to follow the motion of the interface. The grid itself does not actually change, but the North and East porosities, and the z direction inter-nodal distances, are adjusted to give the same effect. This is considerably cheaper computationally than using a distorting BFC grid. The adjustment takes place in the slabs between $IZ0$ and $IZ3$. Slabs in the cathode blocks and above the bottom face of the anodes are not adjusted.

The interface adjustment is based on the principle of maintaining hydrostatic equilibrium across the interface. A reference cell is chosen (the first unblocked cell), and height adjustments are calculated for all other cells based on the pressure difference between the reference cells above and below the interface. Once the adjustments have been applied, the whole interface is moved up or down by a uniform amount in order to preserve the open volume under it. The adjustment sequence is entered every NIH sweeps, once $ISWEEP > IHF$.

A similar adjustment can be performed at the electrolyte free surface, where the inter-anode gaps are open to the atmosphere. This can be switched on by setting $LG(2) = T$.

The vertically directed components of the Lorentz force can be included in the balance equation across the interface by setting $LG(3) = T$.

The initial distribution of the interface height may be read from a file. This is signalled by setting $IG(12) > 0$ - Read anode underside heights from file $CG(6)$ attached to logical unit $IG(12)$.

If $CG(6)$ is set to $Q1$, the data can be included in $Q1$, starting in column 3 or more. The start of the data is marked with $*HUMP$ in column 3.

$CG(6)$ can only be 4 characters long. To use a file name up to 30 characters long, the file name can be set as $SPEDAT(SET,ESTER,HUMP,C,file_name)$.

The true (i.e. distorted) heights of the cell faces are stored in the variable HI . A PHOTON contour map of the interface can thus be obtained by plotting contours of HI at $IZ = IZ1$. It is best to SET CON SCALE PLANE prior to this, as the changes in height on a plane are usually very small.

The variable SURF contains a relief map of the interface – an iso-surface of SURF with the value 0.5 will show a 3D surface of the interface.

Appendix E. ESTER File Formats

The files making up ESTER have the following significances:

ESTRGR.FOR - The ESTER Ground Station. This should be studied together with the Q1 file. It can be found in **phoenics/d_earth/d_spe/d_ester**.

Several example Q1 files are supplied as library cases Y400 – Y412, and Y497. , setting up a twenty-four anode case. These can be found at **/phoenics/d_earth/d_spe/d_mscspp/inplib**.

The input files described below primarily refer to previous versions of ESTER. The descriptions are left for completeness. Only the magnetic field, cathode-current and anode-underside-height files may be used by the current ESTER.

As noted above, the files referred to below may be physically appended to the Q1 file after the STOP line, and not exist as separate files. If they are embedded in Q1 before STOP, then the lines containing the data must be after a PIL comment line (starting column 3) SAVE11BEGIN, and before a PIL comment line SAVE11END.

The Freeze - FRZ (deprecated)

A data file defining the locations and height in IZ slabs of the freeze. The file is appended to the end of the library Q1. The freeze may extend above the interface at IZ1. The numbers indicate the height (in Z slabs) of the freeze in each IX,IY column.

```

      1 1 1 1 1 1 1 1 1 1
      1 0 0 0 0 0 0 0 0 1
      1 0 0 0 0 0 0 0 0 1
      1 0 0 0 0 0 0 0 0 1
      1 0 0 0 0 0 0 0 0 1
      1 0 0 0 0 0 0 0 0 1
      1 0 0 0 0 0 0 0 0 1
      1 0 0 0 0 0 0 0 0 1
      1 0 0 0 0 0 0 0 0 1
      1 0 0 0 0 0 0 0 0 1
      ^
IY | 1 0 0 1 1 0 0 0 0 1
    | 2 1 1 1 1 1 1 1 1 1
    |____>
    IX

```

(IX is along this direction >>>> and IY vertically).

The Cathode Currents - JZC

A data file defining the cathode current distribution. It is important to specify zero cathode current within the freeze, otherwise overflow may result.

Data Format 1 (Deprecated)

The library example is shown below. The numbers specify the current in Amps/m² passing through the centre of each cell face adjacent to the cathode. This is always located at z=0, i.e. low of IZ=1.

```

      0.  0.  0.  0.  0.  0.  0.  0.  0.  0.
      0. -5000. -5000. -5000. -5000. -5000. -5000. -5000. -5000. 0.
      0. -5000. -5000. -5000. -5000. -5000. -5000. -5000. -5000. 0.
      0. -5000. -5000. -5000. -5000. -5000. -5000. -5000. -5000. 0.
      0. -5000. -5000. -5000. -5000. -5000. -5000. -5000. -5000. 0.
      0. -5000. -5000. -5000. -5000. -5000. -5000. -5000. -5000. 0.
      0. -5000. -5000. -5000. -5000. -5000. -5000. -5000. -5000. 0.
      ^
IY | 0. -5000. -5000. 0. 0. -5000. -5000. -5000. -5000. 0.
    | 0. 0. 0. 0. 0. 0. 0. 0. 0. 0.
    |----> IX

```

This format is very inflexible, as it relies on the file containing exactly the correct number of data values. If the computational grid is changed, the file will not be valid.

Data Format 2 (Recommended)

For this reason, an alternative format is available, in which the X and Y coordinates of each data point are specified. Once read in, the currents are interpolated onto the grid in use. As a final adjustment, the interpolated currents are normalised so that the total current is preserved.

The first few lines of such a file are given here as an example:

```

      88          32    4.55E5
-0.70000E+01 -0.20250E+01  0.00000E+00
-0.68391E+01 -0.20250E+01  0.00000E+00
-0.66782E+01 -0.20250E+01  0.00000E+00
-0.65172E+01 -0.20250E+01  0.00000E+00
-0.63563E+01 -0.20250E+01  0.00000E+00
-0.61954E+01 -0.20250E+01  0.00000E+00

```

The first line contains the number of data points in X (NI), the number of data points in Y (NJ) and the total current in Amps. The total current can also be specified as the single item on the second line. The following lines contain the X coordinate, Y coordinate and current density in A/m² at that point. The coordinates are in metres, relative to the centre-point of the cathode.

The coordinate and current data is read by loops similar to:

```

DO J=1,NJ
  DO I=1,NI
    READ() X(I), Y(J), Jz(I,J)
  ENDDO
ENDDO

```

NI and NJ are the values read from the first line of the data file. Blank lines, lines starting with # and any characters after ! are ignored, allowing the file to be commented. A two-stage linear interpolation is performed to get the current at the grid cell centres.

The Anode Locations - ANO (deprecated)

A data file defining the locations of the anodes. The anode locations are actually specified by the ANODE objects and the anode configuration. The data-file method is retained for downward compatibility, but anodes defined this way will be converted to ANODE objects at startup. In the file, a 0 means free volume, a 1 means an anode occupies the cell. The active library example for a 4 anode cell is shown below. The anodes only exist at z locations above IZ = IZ2.

```

      0 0 0 0 0 0 0 0 0 0
      0 1 1 1 0 0 1 1 1 0
      0 1 1 1 0 0 1 1 1 0
      0 1 1 1 0 0 1 1 1 0
      0 0 0 0 0 0 0 0 0 0
      0 0 0 0 0 0 0 0 0 0
      0 1 1 1 0 0 1 1 1 0
^      0 1 1 1 0 0 1 1 1 0
|      0 1 1 1 0 0 1 1 1 0
|      0 0 0 0 0 0 0 0 0 0
|_____> IX

```

The Anode Underside Heights - HAN

A data file defining the height in metres of the anode undersides above the cathode. The anode undersides may be flat, sloped or contoured.

Data Format 1 (Deprecated)

The library example for flat anodes is shown below.

```

0.260 0.260 0.260 0.260 0.260 0.260 0.260 0.260 0.260 0.260
0.260 0.260 0.260 0.260 0.260 0.260 0.260 0.260 0.260 0.260
0.260 0.260 0.260 0.260 0.260 0.260 0.260 0.260 0.260 0.260
0.260 0.260 0.260 0.260 0.260 0.260 0.260 0.260 0.260 0.260
0.260 0.260 0.260 0.260 0.260 0.260 0.260 0.260 0.260 0.260
0.260 0.260 0.260 0.260 0.260 0.260 0.260 0.260 0.260 0.260
0.260 0.260 0.260 0.260 0.260 0.260 0.260 0.260 0.260 0.260
^ 0.260 0.260 0.260 0.260 0.260 0.260 0.260 0.260 0.260 0.260
IY | 0.260 0.260 0.260 0.260 0.260 0.260 0.260 0.260 0.260 0.260
| 0.260 0.260 0.260 0.260 0.260 0.260 0.260 0.260 0.260 0.260
|____>
IX

```

An alternative set of data shown below, indicates how sloped anodes may be introduced. This data should be used for 2-phase calculations, as the gas will tend to move up the slopes towards the central inter-anode gap and then escape.

```

0.260 0.260 0.260 0.260 0.260 0.260 0.260 0.260 0.260 0.260
0.260 0.260 0.260 0.260 0.260 0.260 0.260 0.260 0.260 0.260
0.267 0.267 0.267 0.267 0.267 0.267 0.267 0.267 0.267 0.267
0.274 0.274 0.274 0.274 0.274 0.274 0.274 0.274 0.274 0.274
0.274 0.274 0.274 0.274 0.274 0.274 0.274 0.274 0.274 0.274
0.274 0.274 0.274 0.274 0.274 0.274 0.274 0.274 0.274 0.274
0.274 0.274 0.274 0.274 0.274 0.274 0.274 0.274 0.274 0.274
^ 0.267 0.267 0.267 0.267 0.267 0.267 0.267 0.267 0.267 0.267
IY | 0.260 0.260 0.260 0.260 0.260 0.260 0.260 0.260 0.260 0.260
| 0.260 0.260 0.260 0.260 0.260 0.260 0.260 0.260 0.260 0.260
|____>
IX

```

This format is very inflexible, as it relies on the file containing exactly the correct number of data values. If the computational grid is changed, the file will not be valid.

Data Format 2 (Recommended)

For this reason, an alternative format is available, in which the X and Y coordinates of each data point are specified. Once read in, the anode-underside heights are interpolated onto the grid in use. The first few lines of such a file are given here as an example:

```

56 26
-2.575 -1.285 0.230
-2.475 -1.285 0.230
-2.364 -1.285 0.230
-2.254 -1.285 0.230
-2.143 -1.285 0.230
-2.032 -1.285 0.230

```

The first line contains the number of data points in X (NI) and the number of data points in Y (NJ) The following lines contain the X coordinate, Y coordinate and anode-underside height in m at that point. The coordinates are in metres, relative to the centre-point of the cathode.

The coordinate and height data is read by loops similar to:

```

DO J=1,NJ
  DO I=1,NI
    READ() X(I), Y(J), H(I,J)
  ENDDO
ENDDO

```

NI and NJ are the values read from the first line of the data file. Blank lines, lines starting with # and any characters after ! are ignored, allowing the file to be commented. A two-stage linear interpolation is performed to get the height at the grid cell centres.

The Magnetic Fields – MAGF

A data file specifying the magnetic field components at the cell faces. This file is not used in the active demo, as the magnetic fields are computed from algebraic expressions. No example data is provided. The field components should be defined in Gauss. The field components are deemed to be stored at the cell centres.

Data Format 1 (Deprecated)

The data is read in the order shown below in the sample code. If the file does not contain data for all Z planes, the fields are assumed to remain the same at all Z locations above the last plane read. The following code snippet shows how the values should be ordered.

```
DO IX=1,NX
  DO IY=1,NY
    READ() (Bx(IY,IX),By(IY,IX),Bz(IY,IX),IY=1,NY)
  ENDDO
ENDDO
```

NX, NY are the actual number of cells in X and Y. As with the cathode current file, JZC, this format is inflexible, as each file describes a particular grid distribution.

Data Format 2 (Recommended)

The recommended format of the magnetic field file is the Tecplot 'PLT' format, as shown in the partial example below:

```
TITLE=B on_demand
VARIABLES="X","Y","Z","Bx","By","Bz","Bm"
ZONE T="B1", I=      88, J=      32, K=      10,F=POINT
-0.70000E+01 -0.20250E+01  0.00000E+00 -0.13145E-01  0.84991E-02 -0.59068E-02  0.16731E-01
-0.68391E+01 -0.20250E+01  0.00000E+00 -0.14118E-01  0.75620E-02 -0.68962E-02  0.17437E-01
-0.66782E+01 -0.20250E+01  0.00000E+00 -0.16239E-01  0.72623E-02 -0.69125E-02  0.19085E-01
-0.65172E+01 -0.20250E+01  0.00000E+00 -0.17954E-01  0.77459E-02 -0.58176E-02  0.20401E-01
-0.63563E+01 -0.20250E+01  0.00000E+00 -0.16959E-01  0.74316E-02 -0.53471E-02  0.19272E-01
-0.61954E+01 -0.20250E+01  0.00000E+00 -0.18229E-01  0.63882E-02 -0.51384E-02  0.19988E-01
-0.60345E+01 -0.20250E+01  0.00000E+00 -0.18127E-01  0.76131E-02 -0.44052E-02  0.20148E-01
.....
```

The 'TITLE' line is used to identify the file format. The content of TITLE is not used.

The 'VARIABLES' line is ignored, and could be absent. It is assumed that the data will be in the order stated above, i.e. X co-ordinate, Y co-ordinate, Z co-ordinate, X component, Y component, Z component, magnitude. The coordinates are in metres, relative to the centre-point of the cathode.

The 'ZONE' line is used to find the number of data points in X (I= NI), Y (J= NJ) and Z (K= NK). The 'T=' and 'F=' flags are not used. The remainder of the file is read using loops like:

```
DO K=1,NK
  DO J=1,NJ
    DO I=1,NI
      READ() XC(I),YC(J),ZC(K), BX(I,J,K),BY(I,J,K),BZ(I,J,K),BM
    ENDDO
  ENDDO
ENDDO
```

The Cell Face Locations - GRID.TXT

This is an output file containing the numbers of cells and cell face locations in each coordinate direction. A very simple example file is shown here:

```

5 = nx
0.1500  1.8750  2.1250  3.8500  4.0000
9 = ny
0.1500  1.9643  3.7786  5.5929  7.4071  9.2214  11.0357  12.8500  13.0000
5 = nz
0.1000  0.2000  0.2200  0.2400  0.4000

```

Additional Monitoring

Interface Height: hintn.txt

A sequence of files containing the interface height distribution at sweep or step n. An extract from a typical file is shown here:

```

          0.0395  0.0992  0.1397  0.1905  0.2577  0.3250  0.3879  0.4526  0.5150
3.1675  0.5963  0.5967  0.5971  0.5976  0.5989  0.6008  0.6027  0.6050  0.6075
3.1445  0.5957  0.5958  0.5962  0.5967  0.5981  0.5998  0.6017  0.6039  0.6064
3.1253  0.5954  0.5953  0.5957  0.5965  0.5981  0.6001  0.6020  0.6041  0.6065
3.1094  0.5951  0.5949  0.5955  0.5966  0.5985  0.6005  0.6024  0.6045  0.6068
3.0960  0.5949  0.5947  0.5954  0.5968  0.5989  0.6011  0.6030  0.6050  0.6073
3.0850  0.5948  0.5946  0.5954  0.5972  0.5995  0.6016  0.6035  0.6055  0.6077
3.0726  0.5947  0.5946  0.5955  0.5977  0.6001  0.6023  0.6041  0.6060  0.6081
3.0562  0.5946  0.5946  0.5957  0.5981  0.6007  0.6029  0.6047  0.6065  0.6085
3.0366  0.5947  0.5948  0.5960  0.5987  0.6013  0.6035  0.6053  0.6070  0.6090
3.0131  0.5949  0.5952  0.5964  0.5993  0.6019  0.6041  0.6058  0.6075  0.6093
2.9849  0.5952  0.5959  0.5970  0.6000  0.6025  0.6045  0.6061  0.6078  0.6095

```

The first line contains the X co-ordinate for each X location. The subsequent lines contain the Y co-ordinate as the first entry followed by the interface height at each X location. In the above extract the red values are X co-ordinates and the green Y co-ordinates.

Individual Height monitor: hi-mon-n.csv

Up to 5 files containing the interface height at a position as a function of sweep or time for transient cases. An extract from a typical transient file is shown here:

```

TIME, HI_1
4.000000E+00, 1.727117E-01
8.000000E+00, 1.757539E-01

1.200000E+01, 1.795289E-01
1.600000E+01, 1.836075E-01
2.000000E+01, 1.876970E-01
2.400000E+01, 1.916234E-01
2.800000E+01, 1.953025E-01
3.200000E+01, 1.987072E-01
3.600000E+01, 2.018405E-01

```

Collector-bar Currents file: cbars_1.csv and cbars_2.csv

Two files containing the odd- and even-numbered collector-bar currents in Amps as a function of sweep or time. An extract from a typical file is shown here:

```

ISWEEP, J_01, J_03, J_05, J_07, J_09, J_11, J_13, J_15, J_17, J_19, J_21, J_23, J_25, J_27
1, -7.142855E+03, -7.142853E+03, -7.142855E+03, -7.142849E+03, -7.142861E+03, ...
2, -7.142855E+03, -7.142853E+03, -7.142855E+03, -7.142849E+03, -7.142861E+03, ...

```

```

3, -7.142855E+03, -7.142853E+03, -7.142855E+03, -7.142849E+03, -7.142861E+03, ...
4, -7.142855E+03, -7.142853E+03, -7.142855E+03, -7.142849E+03, -7.142861E+03, ...
5, -7.142855E+03, -7.142853E+03, -7.142855E+03, -7.142849E+03, -7.142861E+03, ...
6, -7.142855E+03, -7.142853E+03, -7.142855E+03, -7.142849E+03, -7.142861E+03, ...
7, -7.142855E+03, -7.142853E+03, -7.142855E+03, -7.142849E+03, -7.142861E+03, ...
8, -7.142855E+03, -7.142853E+03, -7.142855E+03, -7.142849E+03, -7.142861E+03, ...

```

Anode-rod Currents files: rods_j_1.csv and rods_j_2.csv

Two files containing the currents in the odd- and even-numbered anode rods in Amps/m² as a function of sweep or time. An extract from a typical _1 file is shown here:

```

ISWEEP, J_01, J_03, J_05, J_07, J_09, J_11, J_13, J_15, J_17, J_19, J_21, J_23
1, 0.000000E+00, 0.000000E+00, 0.000000E+00, 0.000000E+00, 0.000000E+00, ...
2, -3.831848E+05, -3.812878E+05, -4.118300E+05, -3.942508E+05, -3.805764E+05, ...
3, -5.162616E+05, -5.096694E+05, -5.048004E+05, -5.467090E+05, -5.087051E+05, ...
4, -3.394898E+05, -3.317594E+05, -2.820572E+05, -3.813668E+05, -3.364071E+05, ...
5, -3.064972E+05, -3.004268E+05, -2.610633E+05, -3.474573E+05, -3.081413E+05, ...
6, -3.448173E+05, -3.391578E+05, -3.067186E+05, -3.863781E+05, -3.478842E+05, ...
7, -4.104862E+05, -4.041154E+05, -3.736206E+05, -4.548452E+05, -4.123042E+05, ...
8, -4.754754E+05, -4.677767E+05, -4.330293E+05, -5.233913E+05, -4.747957E+05, ...

```

Anode-rod Voltage files: rods_v_1.csv and rods_v_2.csv

Two files containing the voltages in the odd- and even-numbered anode rods in Volts as a function of sweep or time. An extract from a typical _1 file is shown here:

```

ISWEEP, V_01, V_03, V_05, V_07, V_09, V_11, V_13, V_15, V_17, V_19, V_21, V_23
1, 2.992688E+00, 2.992724E+00, 2.991781E+00, 2.992755E+00, 2.992738E+00, ...
2, 2.990149E+00, 2.990275E+00, 2.989929E+00, 2.989952E+00, 2.990293E+00, ...
3, 2.993522E+00, 2.993669E+00, 2.994379E+00, 2.992990E+00, 2.993581E+00, ...
4, 2.994152E+00, 2.994267E+00, 2.994794E+00, 2.993613E+00, 2.994120E+00, ...
5, 2.993421E+00, 2.993529E+00, 2.993882E+00, 2.992898E+00, 2.993362E+00, ...
6, 2.992168E+00, 2.992289E+00, 2.992547E+00, 2.991640E+00, 2.992133E+00, ...
7, 2.990928E+00, 2.991074E+00, 2.991362E+00, 2.990380E+00, 2.990941E+00, ...
8, 2.989577E+00, 2.989769E+00, 2.990113E+00, 2.989021E+00, 2.989674E+00, ...

```